



rd rujzdesign

2023



rd rujzdesign



**0** uvod  
intro

**1** izdelki iz aluminija  
aluminium products



**2** kovinski ročaji in gumbi  
metal handles and knobs



**3** ročaji in gumbi iz lesa  
wooden handles and knobs



**4** plastični in usnjeni ročaji  
plastic and leather handles



**5** obešalniki  
hooks



**6** cubus profilni sistem  
cubus profiles system



**7** noge & podnožni sistem  
legs & leg frame system



**8** galvanizacija ter posebni izdelki  
galvanization and custom products



**intro** uvod

362.21

ŠIFRA ARTIKLA  
ARTICLE CODE



OSNA RAZDALJA MED VIJAKI  
DISTANCE BETWEEN SCREWS



DOLŽINA  
LENGTH



PREMER ENOVIJAČNEGA ROČAJA  
SINGLE SCREWED HANDLE DIAMETER



VIŠINA  
HEIGHT



ŠIRINA  
WIDTH



DIMENZIJA POGLOBITVE  
DEEPENING DIMENSION



GLOBINA POGLOBITVE  
DEPTH OF DEEPENING



VIŠINA ZUNANJEGA DELA  
HEIGHT OF EXTERNAL PART



NASTAVLJIVO PO VIŠINI  
HEIGHT-ADJUSTABLE



GLOBINA  
DEPTH



ŠIRINA  
WIDTH



GLOBINA  
DEPTH



VIŠINA  
HEIGHT



VIŠINA  
HEIGHT



ŠIRINA X DOLŽINA  
WIDTH X LENGTH



ŠIRINA X DOLŽINA X VIŠINA  
WIDTH X LENGTH X HEIGHT



ALUMINIJ  
ALUMINIUM



KOVINA  
METAL



LES  
WOOD



PLASTIKA  
PLASTIC



STEKLO  
GLASS



USNJE  
LEATHER



PRAVI KARBON  
REAL CARBON



DOLŽINE PO NAROČILU  
CUSTOM LENGTH



OSNA RAZDALJA  
DISTANCE BETWEEN SCREWS



## eloxirane površinske obdelave anodized surface treatments



**031** MCrE



**091** MCrESat



**096** Sat2



**055** Silver



**047** NiSatE



**097** NiSatE2



**314** BNiE



**088** SatBNiE



**309** PMBNiE



**034** MCrNE



**049** SatCrNE



**345** PMCrNE



**305** CuE



**036** SatCuE



**310** PMCuE



**050** AuE2



**316** SatAuE2



**318** PMAuE2



**053** SilverP



**094** SilverPHG



**318** BronzE



**319** SatBronzE



**344** PMBronzE



## galvanske površinske obdelave galvanic surface treatments



**012** Cr



**020** MCrG



**016** MNiG



**013** Ni



**026** NiSat



**035** NiSatM



**023** BNiG



**087** BNiGM



**321** PCuG



**011** Au



**322** MAuG





## lakirane površinske obdelave painted finishes

					
<b>021 MCrL</b> ⊗ ⊞ ⊕	<b>032 MCrEL</b> ⊗ ⊞ ⊕	<b>089 SatMCrL</b> ⊞ ⊕	<b>017 MNiL</b> ⊗ ⊞ ⊕	<b>063 NiL</b> ⊗ ⊞ ⊕	<b>062 SNiL</b> ⊞ ⊕
					
<b>029 SatCrNL</b> ⊞ ⊕	<b>064 TitL</b> ⊗ ⊞ ⊕	<b>311 BNiL</b> ⊗ ⊞ ⊕	<b>068 SatBNiL</b> ⊞ ⊕	<b>376 BlackL str3</b> ⊗ ⊞ ⊕	<b>377 GreyL str2</b> ⊗ ⊞ ⊕
					
<b>072 Vint</b> ⊞ ⊕	<b>098 Vint2</b> ⊞ ⊕	<b>015 MsPatL</b> ⊗ ⊞ ⊕	<b>014 BPatL</b> ⊗ ⊞ ⊕	<b>028 MAuL</b> ⊗ ⊞ ⊕	<b>061 SatAuL</b> ⊞ ⊕
					
<b>306 CuL</b> ⊗ ⊞ ⊕	<b>076 SatCuL</b> ⊞ ⊕	<b>328 BronzL</b> ⊗ ⊞ ⊕	<b>329 SatBronzL</b> ⊞ ⊕		
					
<b>024 White</b> ⊗ ⊞ ⊕	<b>025 Black</b> ⊗ ⊞ ⊕	<b>404 Yellow1</b> ⊗ ⊞ ⊕	<b>407 Orange1</b> ⊗ ⊞ ⊕	<b>408 Orange2</b> ⊗ ⊞ ⊕	<b>409 Beige</b> ⊗ ⊞ ⊕
					
<b>410 Red1</b> ⊗ ⊞ ⊕	<b>412 Pink</b> ⊗ ⊞ ⊕	<b>416 Blue</b> ⊗ ⊞ ⊕	<b>421 Green2</b> ⊗ ⊞ ⊕	<b>423 Green4</b> ⊗ ⊞ ⊕	<b>452 Grey1</b> ⊗ ⊞ ⊕
					
<b>491 Barby Violet</b> ⊗ ⊞ ⊕	<b>490 Barby Yellow</b> ⊗ ⊞ ⊕	<b>488 Barby Green</b> ⊗ ⊞ ⊕	<b>489 Barby Blue</b> ⊗ ⊞ ⊕		

## najpomembnejše vrste lesa in njihove površinske obdelave most important woods and wooden finishes



				
<b>215 Oak</b> ⊕	<b>189 Oak Wenge</b> ⊕	<b>102 Beech Natur</b> ⊕	<b>105 Beech Toned P</b> ⊕	<b>240 Walnut Natur</b> ⊕

# 1 izdelki iz aluminija aluminium products



1.1

ročaji  
aluminium handles

 595.28B / 027	 520.28 / 026	 520.20 / 026	 520.15 / 026	 698.20 / 027	 595.28 / 027
 618.15 / 029	 574.10 / 028	 573.15 / 028	 573.20 / 028	 678.12 / 029	 619.10 / 029
 634.10 / 031	 653.15 / 029	 673.22 / 030	 620.20 / 030	 638.27B / 030	 614.16 / 031
 341.13 / 033	 688.12 / 031	 570.80 / 032	 570.60 / 032	 570.40 / 032	 525.27 / 032
 642.20 / 034	 341.10 / 033	 640.10 / 033	 632.27B / 033	 424.29 / 034	 617.33 / 034
 553.28 / 036	 644.16 / 035	 581.28 / 035	 528.02 / 035	 648.17 / 036	 513.10B / 036
 631.22B / 038	 534.25 / 036	 646.32 / 037	 708.15 / 037	 426.25 / 037	 631.22A / 038
 546.12 / 040	 651.24 / 039	 683.15 / 039	 682.15 / 039	 550.10 / 040	 627.10 / 040
 561.20 / 042	 476.15 / 041	 715.13B / 043	 347.20 / 041	 369.16 / 041	 713.12 / 042
 693.20 / 042	 715.13C / 043	 715.13D / 043	 715.13/1 / 043		

 <b>285.13</b> / 043	 <b>285.13B</b> / 043	 <b>572.35</b> / 043	 <b>208.10</b> / 044	 <b>208.10B</b> / 044	 <b>208.10C</b> / 044
 <b>624.12BL</b> / 044	 <b>624.12CL</b> / 044	 <b>679.12L</b> / 044	 <b>242.13</b> / 044	 <b>242.13B</b> / 044	 <b>242.13C</b> / 044
 <b>611.08</b> / 045	 <b>611.08B</b> / 045	 <b>612.08</b> / 045	 <b>404.16</b> / 045	 <b>404.16B</b> / 045	 <b>709.16</b> / 046
 <b>567.19</b> / 046	 <b>490.17</b> / 046	 <b>613.27B</b> / 047	 <b>427.27</b> / 047	 <b>670.20</b> / 047	 <b>357.25</b> / 048
 <b>375.24</b> / 048	 <b>390.25</b> / 048	 <b>374.21</b> / 049	 <b>410.20</b> / 049	 <b>333.08</b> / 049	 <b>531.24</b> / 050
 <b>576.28</b> / 050	 <b>327.24</b> / 050	 <b>328.20B</b> / 051	 <b>675.25</b> / 051	 <b>U10/15</b> / 053	 <b>U11/14</b> / 053

## 1.2

profili za omare  
wardrobe profiles



2168 / 053



2169 / 053



401.40 / 054



452.21 / 054



345.18 / 054



2198B / 054



2198 / 054



326.15B / 054



2159B / 054



2159A / 054



2159C / 054



2159D / 054



2197B / 054



2197A / 054



2197 / 054



325.37 / 055



10.002 / 055



555.95 / 055



2192 / 055



658.35 / 055



466.43 / 055



643.33 / 055



606.40 / 055



444.25 / 055



445.25 / 055



2107 / 055



552.15 / 055

## 1.3

ročaji za omare  
wardrobe handles



665.12 / 057



684.12 / 057



525.27 / 057



561.20 / 057



568.28 / 057



697.14B / 059

NOVO  
NEW



697.14C / 059

NOVO  
NEW



690.16 / 059



693.20 / 059



708.15 / 059

NOVO  
NEW

## 1.4

ukrivljeni ročaji  
iz aluminija  
curved aluminium  
handles



520.20C / 061



574.10C / 061



632.27BC / 061

## 1.5

ročaji za  
kopalnice  
bathroom handles



616.08 / 062



616.08B / 062



2109A / 063



2188 / 063



2144 / 063



2189 / 063

## 1.6

vsadni ročaji  
integrated handles



555.95 / 065



555.97 / 065



10.002 / 065



10.003 / 065



2192 / 066



2222 / 066



2192B / 066



2222B / 066



2192C / 066



2222C / 066



2192D / 067



2222D / 067



10.005 / 067



464.35 / 067



2118 / 067



398.37 / 068



2141 / 068



2217 / 068



2139 / 069



2159A / 069



2159B / 069



2159C / 069



2159D / 069



2198 / 070



2198B / 070



2197 / 070



2197A / 070



2197B / 070



401.40 / 071



345.18 / 071



452.21 / 071



441.97 / 072



2142 / 072



326.15B / 072



10.001 / 073



10.001B / 073



690.16 / 073



690.16L (R) / 073



697.14B / 074



697.14C / 074

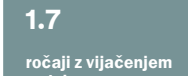

12.002A / 076



466.43 / 076



656.35 / 078



643.33 / 078



658.35 / 078

## 1.7

ročaji z vijačenjem  
zadaj  
backside screw  
handles



658.35 / 078



606.40 / 079

























609.18 / 079



609.18D / 079













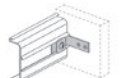
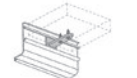

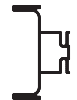
## 1.8

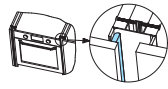
### utopni ročaji embedded handles

 <b>326.15</b> / 080	 <b>455.18</b> / 080	 <b>433.21</b> / 080	 <b>326.15L (D)</b> / 081	 <b>U11.14</b> / 081
 <b>586.14</b> / 081	 <b>2171</b> / 082	 <b>674.15</b> / 082	 <b>674.15B</b> / 082	 <b>675.25</b> / 083
 <b>675.25CL (R)</b> / 083	 <b>437.20</b> / 084	 <b>615.13</b> / 084	 <b>435.30</b> / 084	 <b>U11.003</b> / 085
 <b>U7.180/40</b> / 085	 <b>U12AC</b> / 086	 <b>U12AE</b> / 086	 <b>U11.001/35</b> / 086	 <b>U9.41/41</b> / 087
			 <b>U11.001/50</b> / 086	 <b>U9.175/55</b> / 087
				 <b>U6.137/45</b> / 087

## 1.9

### gola profilni sistemi gola profile systems

 <b>2199L</b> / 089	 <b>2199C</b> / 089	 <b>2199K</b> / 089	 <b>2199T-18 / T-19</b> / 089	 <b>2199P</b> / 089
 <b>2200C</b> / 090	 <b>2200L</b> / 090	 <b>2200P</b> / 090	 <b>2199C.F</b> / 091	 <b>2199L.F</b> / 091
 <b>2199L.E</b> / 091	 <b>2199L.I</b> / 091	 <b>2199L.O</b> / 091	 <b>2199C.IS</b> / 091	 <b>2199L.IS</b> / 091
 <b>2199L.OS</b> / 091				

## 1.10

### bagažerji luggage rack bars

 <b>80.001</b> / 093	 <b>80.002</b> / 093	 <b>80.003</b> / 093
--	--	--

## 2 kovinski ročajji in gumbi metal handles and knobs



### 2.1

kovinski ročajji  
in gumbi  
metal handles  
and knobs



691.26 / 096



692.18 / 096



588.25 / 096



587.25 / 097



696.15 / 097

NOVO  
NOVO



685.10 / 097



703.14 / 098

NOVO  
NOVO



700.14 / 098

NOVO  
NOVO



689.14 / 099

NOVO  
NOVO



694.16 / 099

NOVO  
NOVO



669.15 / 099



667.20 / 100



668.15 / 100



580.26sw / 100

NOVO  
NOVO  
SWAROVSKI  
ELEMENTS



580.26 / 100



836.26 / 100



354.25 / 101

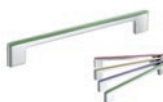

677.08 / 101



604.27 / 101



415.26R / 102



495.25 / 102



529.27 / 102



516.30 / 103



826.30 / 103



516.30B / 103



826.30B / 103



516.30E / 103



826.30E / 103



446.24R / 104



447.20R / 104



497.22 / 104



360.28 / 105



367.20 / 105



496.14 / 105



603.29 / 105



361.25 / 106



362.21 / 106



462.25 / 106



362.21A / 106



396.25 / 106



362.21D / 106



498.16 / 107



536.16 / 107



569.28 / 107



832.28 / 107



527.13 / 107



527.13B / 107



370.30 / 108



387.20 / 108



386.20 / 108



311.20 / 108



219.08 / 109



219.10 / 109



304.16 / 109



583.19 / 109



590.01 / 110



590.02 / 110



590.03 / 110



528.03 / 110





































 <b>501.10</b> / 110	 <b>500.10</b> / 110	 <b>502.10</b> / 110	 <b>557.02</b> / 111	 <b>557.04</b> / 111	 <b>557.01</b> / 111
 <b>557.03</b> / 111	 <b>437.20</b> / 111	 <b>667.20</b> / 112	 <b>199.15D</b> / 112	 <b>199.15</b> / 112	 <b>823.18</b> / 112
 <b>805.13</b> / 112	 <b>836.26</b> / 112	 <b>454.20</b> / 112	 <b>584.19</b> / 112	 <b>510.34</b> / 112	 <b>807.24</b> / 112
 <b>160.12</b> / 112	 <b>834.11</b> / 113	 <b>832.28</b> / 113	 <b>803.25</b> / 113	 <b>825.32</b> / 113	 <b>652.20</b> / 113
 <b>653.15</b> / 113	 <b>833.20</b> / 113	 <b>850.40</b> / 113	 <b>613.27B</b> / 113	 <b>567.19</b> / 113	 <b>328.20B</b> / 113
 <b>564.27</b> / 113	 <b>851.40</b> / 114	 <b>851.30</b> / 114	 <b>163.26</b> / 114	 <b>809.24</b> / 114	 <b>367.20</b> / 114
 <b>311.20</b> / 114	 <b>819.32</b> / 114	 <b>804.15</b> / 114	 <b>362.21C</b> / 114	 <b>362.21B</b> / 114	 <b>826.30D</b> / 114
 <b>826.30B</b> / 114	 <b>170.18</b> / 115	 <b>161.19</b> / 115	 <b>162.24</b> / 115	 <b>MS 7.25</b> / 115	 <b>MS 5.20</b> / 115
 <b>MS 5.25</b> / 115	 <b>MS 6.38</b> / 115	 <b>MS 6.32</b> / 115	 <b>MS 6.25</b> / 115	 <b>MS 3.28</b> / 115	 <b>MS 4.28</b> / 115
<b>2.2</b> vintage kovinski ročaji in gumbi vintage metal handles and knobs	 <b>630.15</b> / 117	 <b>636.15</b> / 117	 <b>667.20</b> / 117	 <b>650.12</b> / 118	 <b>657.16</b> / 118
 <b>347.20</b> / 118	 <b>354.25</b> / 119	 <b>516.30C</b> / 119	 <b>826.30C</b> / 119	 <b>590.01</b> / 119	 <b>590.02</b> / 119



 <b>590.03</b> / 119	 <b>651.24</b> / 120	 <b>668.15</b> / 120	 <b>619.10</b> / 120	 <b>387.20</b> / 121	 <b>386.20</b> / 121
 <b>583.19</b> / 121	 <b>561.20</b> / 122	 <b>415.26R</b> / 122	 <b>529.27</b> / 122	 <b>613.27B</b> / 123	 <b>700.14</b> / 123
 <b>U9.41</b> / 41 / 123	 <b>U9.175</b> / 55 / 123	 <b>454.20</b> / 124	 <b>199.15D</b> / 124	 <b>851.30</b> / 40 / 124	 <b>589.01</b> / 124
 <b>589.02</b> / 124	 <b>448.51R</b> / 124	 <b>449.95</b> / 124	 <b>2202C</b> / 125	 <b>2187C</b> / 125	 <b>2202A</b> / 125
 <b>2187A</b> / 125	 <b>2084</b> / 126	 <b>2130</b> / 126	 <b>40.010</b> / 126	 <b>2116</b> / 126	 <b>2203</b> / 126
<b>2.3</b> klasični ročaji classic handles	 <b>631.22B</b> / 129	 <b>667.20</b> / 129	 <b>650.12</b> / 129	 <b>589.02</b> / 130	 <b>589.01</b> / 130
 <b>516.30C</b> / 130	 <b>826.30C</b> / 130	 <b>516.30B</b> / 130	 <b>826.30B</b> / 130	 <b>236.16</b> / 131	 <b>128.18</b> / 131
 <b>681.15</b> / 131	 <b>386.20</b> / 131	 <b>311.20</b> / 131	 <b>416.14</b> / 132	 <b>815.14</b> / 132	 <b>298.12</b> / 132
 <b>220.10+P4</b> / 132	 <b>851.30</b> / 132	 <b>MS 3.28</b> / 132	 <b>MS 7.25</b> / 132	 <b>162.24</b> / 133	 <b>199.15D</b> / 133
 <b>170.18</b> / 133	 <b>114.30</b> / 133	 <b>114.30+P3</b> / 133	 <b>118.30</b> / 133	 <b>171.32</b> / 133	 <b>259.18</b> / 133
 <b>285.13</b> / 133	 <b>636.15</b> / 134	 <b>269.22</b> / 134			

















### 3 leseni ročaji in gumbi wooden handles and knobs



 414.14 / 140	 613.27B / 140	 347.20 / 140	 289.26 / 141	 166.10 / 141	 556.10 / 141
 830.10 / 141	 539.01A / 141	 539.02A / 141	 539.03A / 141	 493.35 / 142	 350.43 / 142
 476.15 / 142	 541.15 / 143	 237.13 / 143	 285.13 / 143	 259.18 / 143	 204.16 / 143
 213.14 / 143	 221.10 / 143	 U1.150 / 144	 U3.150 / 144	 U2.150 / 144	 U2.140 / 144
 U2.135 / 144	 114.30 / 144	 114.30+P3 / 144	 118.30 / 144	 810.18 / 145	 132.25D / 145
 149.35 / 145	 144.32 / 145	 171.32 / 145	 L1.05.36 / 145	 L1.03.32 / 145	 L1.04.35 / 145

### 4 plastični in usnjeni ročaji plastic and leather handles



4.1 plastični ročaji plastic handles	 154.40 / 148	 816.70 / 148	 842.30 / 148	 847.24 / 148	 155.40 / 148
 277.32 / 148	 472.52 / 148	 469.50 / 148	 470.50 / 148	 471.55 / 148	 506.32 / 148
 601.26 / 148	 843.22 / 149	 844.24 / 149	 845.27 / 149	 846.25 / 149	 169.30 / 149



117.30 / 149



106.14 / 149



132.25D / 149



109.20 / 149



118.30 / 149



114.30 / 149



171.32 / 149



600.01 / 150



600.02 / 150



600.03 / 150



600.04 / 150



600.05 / 150



600.06 / 150



600.07 / 150



600.08 / 150



600.09 / 150



600.00 / 150



828.40 / 151



829.100 / 151



596.22 / 151



597.22 / 151



598.32 / 151



599.30 / 151



530.24 / 151



302.20 / 151



222.13 / 152



104.14 / 152



285.13 / 152



U2.150 / 152



331.16 / 152



801.16 / 152



241.08 / 153



299.08 / 153



2153 / 153



2154 / 153



2155 / 153



2156 / 153



2157 / 153

## 4.2

usnjeni ročaji  
leather handles



591.15 / 154



592.15 / 154



516.30F / 154



826.30F / 154



322.16 / 155



577.19 / 155



855.25 / 155



157.16 / 155

# 5 obešalniki hooks



 <b>40.004</b> / 158	 <b>40.005</b> / 158	 <b>40.010</b> / 158	 <b>40.008</b> / 158	 <b>40.009</b> / 158	 <b>2123</b> / 160
 <b>2124</b> / 160	 <b>2130</b> / 160	 <b>2131</b> / 160	 <b>2084</b> / 160	 <b>40.003</b> / 161	 <b>40.003B</b> / 161
 <b>2045</b> / 161	 <b>2202A</b> / 162	 <b>2187A</b> / 162	 <b>2187C</b> / 162	 <b>2202C</b> / 162	 <b>2018</b> / 163
 <b>2053</b> / 163	 <b>2037</b> / 163	 <b>2100</b> / 163	 <b>652.20</b> / 163	 <b>2127</b> / 163	 <b>2088</b> / 164
 <b>2121</b> / 164	 <b>2014</b> / 164	 <b>2028</b> / 164	 <b>2013</b> / 165	 <b>2030</b> / 165	 <b>2015</b> / 165
 <b>2001</b> / 165	 <b>2004</b> / 165	 <b>2043</b> / 166	 <b>2033</b> / 166	 <b>2120</b> / 166	 <b>2081</b> / 167
 <b>2082</b> / 167	 <b>2010</b> / 167	 <b>169.30</b> / 167	 <b>2087</b> / 167	 <b>2090</b> / 168	 <b>2092</b> / 168

## 6 cubus profilni sistem cubus profiles system



61.001 / 173

## 7 noge & podnožni sistem legs & leg frame system



2178R / 178



2184B / 178



2150 / 178



2158 / 178



2064 / 178



2067 / 178



2073 / 178



2066 / 178



2070 / 178



2072 / 179



2151 / 179



2062 / 179



2059 / 179



2057 / 179



2017 / 179



2152 / 179



3002 / 179



2116 / 180



2203 / 180

## 8 galvanizacija ter posebni izdelki galvanization and custom products



8.2

posebni izdelki  
custom products



2016 / 191

ART.	STRAN/PAGE
10.001	73
10.001B	73
10.002	55,65
10.003	65
10.005	67
104.14	152
106.14	149
109.20	149
114.30	133,144,149
114.30+P3	133,144
117.30	149
118.30	133,144,149
12.002A	76
12.002B	76
128.18	131
132.25D	145,149
144.32	145
149.35	145
154.40	148
155.40	148
157.16	155
160.12	112
161.19	115
162.24	115,133
163.26	114
166.10	141
169.30	149,167
170.18	115,133
171.32	133,145,149
199.15	112
199.15D	112,124,133
2001	165
2004	165
2010	167
2013	165
2014	164
2015	165
2016	191
2017	179
2018	163
2028	164
2030	165
2033	166
2037	163
204.16	143
2043	166
2045	161
2046	161
2053	163
2057	179
2059	179
2062	179
2064	178
2066	178
2067	178
2070	178
2072	179
2073	178
208.10	44
208.10B	44
208.10C	44
2081	167
2082	167
2084	126,160
2087	167
2088	164
2090	168
2092	168
2100	163
2107	55
2109A	63
2116.1	126
2116.2	126
2118	67
2120	166
2121	164
2123	160
2124	160
2127	163
213.14	143
2130	126,160
2131	160
2139	54,69

ART.	STRAN/PAGE
2141	68
2142	72
2144	63
2150	178
2151	179
2152	179
2153	153
2154	153
2155	153
2156	153
2157	153
2158	178
2159A	54,69
2159B	54,69
2159C	54,69
2159D	54,69
2168	53
2169	53
2171	82
2178R	178
2184B	178
2187A	125,162
2187C	125,162
2188	63
2189	63
219.08	109
219.10	109
2192	55,66
2192B	66
2192C	66
2192D	67
2197	54,70
2197A	54,70
2197B	54,70
2198	54,70
2198B	54,70
2199C	89
2199C.E	91
2199C.F	91
2199C.IS	91
2199C.OS	91
2199K	89
2199L	89
2199L.E	91
2199L.F	91
2199L.I	91
2199L.IS	91
2199L.O	91
2199L.OS	91
2199P	89
2199T-18 / T-19	89
220.10+P4	132
2200C	90
2200L	90
2200P	90
2202A	125,162
2202C	125,162
2203.1	126
2203.2	126
221.10	143
2217	68
222.13	152
2222	66
2222B	66
2222C	66
2222D	67
236.16	131
237.13	143
241.08	153
242.13	44
242.13B	44
242.13C	44
259.18	133,143
269.22	134
277.32	148
285.13	43,133,143,152
285.13B	43
289.26	141
298.12	132
299.08	153
30.001	185
3002	179
302.20	151

ART.	STRAN/PAGE
304.16	109
311.20	108,114,131
322.16	155
325.37	55
326.15	80
326.15B	54,72
326.15D	81
326.15L	81
327.24	50
328.20B	51,113
331.16	152
333.08	49
341.10	33
341.13	33
345.18	54,71
347.20	41,118,140
350.43	142
354.25	101,119
357.25	48
360.28	105
361.25	106
362.21	106
362.21A	106
362.21B	114
362.21C	114
362.21D	106
367.20	105,114
369.16	41
370.30	108
374.21	49
375.24	48
386.20	108,121,131
387.20	108,121
390.25	48
396.25	106
398.37	68
40.003	161
40.003B	161
40.004	158
40.005	158
40.008	158
40.009	158
40.010	126,158
401.40	54,71
403.07	85
404.16	45
404.16B	45
410.20	49
414.14	140
415.26R	102,122
416.14	132
424.29	34
426.25	37
427.27	47
433.21	80
435.30	84
437.20	84,111
441.97	72
444.25	55
445.25	55
446.24R	104
447.20R	104
448.51R	124
449.95	124
452.21	54,71
454.20	112,124
455.18	80
462.25	106
464.35	67
466.43	55,76
469.50	148
470.50	148
471.55	148
472.52	148
476.15	41,142
490.17	46
493.35	142
495.25	102
496.14	105
497.22	104
498.16	107
500.10	110
501.10	110

ART. STRAN/PAGE

502.10 110  
506.32 148  
510.34 112  
513.10B 36  
516.30 103  
516.30B 103,130  
516.30C 119,130  
516.30E 103  
516.30F 154  
520.15 26  
520.20 26  
520.20C 61  
520.28 26  
525.27 32,57  
527.13 107  
527.13B 107  
528.02 35  
528.03 110  
529.27 102,122  
530.24 151  
531.24 50  
534.25 36  
536.16 107  
539.01A 141  
539.02A 141  
539.03A 141  
541.15 143  
546.12 40  
546.12B 40  
550.10 40  
552.15 55  
553.28 36  
555.95 55,65  
555.97 65  
556.10 141  
557.01 111  
557.02 111  
557.03 111  
557.04 111  
561.20 42,57,122  
564.27 113  
567.19 46,113  
568.28 57  
569.28 107  
570.40 32  
570.60 32  
570.80 32  
572.35 43  
573.15 28  
573.20 28  
574.10 28  
574.10C 61  
576.28 50  
577.19 155  
580.26 100  
580.26sw 100  
581.28 35  
583.19 109,121  
584.19 112  
586.14 81  
587.25 97  
588.25 96  
589.01 124,130  
589.02 124,130  
590.01 110,119  
590.02 110,119  
590.03 110,119  
591.15 154  
592.15 154  
595.28 27  
595.28B 27  
596.22 151  
597.22 151  
598.32 151  
599.30 151  
600.00 150  
600.01 150  
600.02 150  
600.03 150  
600.04 150  
600.05 150  
600.06 150  
600.07 150

ART. STRAN/PAGE

600.08 150  
600.09 150  
601.26 148  
603.29 105  
604.27 101  
606.40 55,79  
609.18 79  
609.18D 79  
61.001 173,174  
611.08 45  
611.08B 45  
612.08 45  
613.27B 47,113,123,140  
614.16 31  
615.13 84  
616.08 62  
616.08B 62  
617.33 34  
618.15 29  
619.10 29,120  
620.20 30  
624.12BL 44  
624.12CL 44  
627.10 40  
630.15 117  
631.22A 38  
631.22B 38,129  
632.27B 33  
632.27BC 61  
634.10 31  
636.15 117,134  
638.27B 30  
640.10 33  
642.20 34  
643.33 55,78  
644.16 35  
646.32 37  
648.17 36  
650.12 118,129  
651.24 39,120  
652.20 113,163  
653.15 29,113  
656.35 78  
657.16 118  
658.35 55,78  
665.12 57  
667.20 100,112,117,129  
668.15 100,120  
669.15 99  
670.20 47  
673.22 30  
674.15 82  
674.15B 82  
675.25 51,83  
675.25B 83  
675.25CL (R) 83  
677.08 101  
678.12 29  
679.12L 44  
681.15 131  
682.15 39  
683.15 39  
684.12 57  
685.10 97  
688.12 31  
689.14 99  
690.16 59,73  
690.16L (R) 73  
691.26 96  
692.18 96  
693.20 42,59  
694.16 99  
696.15 97  
697.14B 59,74  
697.14C 59,74  
698.20 27  
700.14 98,123  
703.14 98  
708.15 37,59  
709.16 46  
713.12 42  
715.13/1 43  
715.13B 43

ART. STRAN/PAGE

715.13C 43  
715.13D 43  
80.001 93  
80.002 93  
80.003 93  
801.16 152  
803.25 113  
804.15 114  
805.13 112  
807.24 112  
809.24 114  
810.18 145  
815.14 132  
816.70 148  
819.32 114  
823.18 112  
825.32 113  
826.30 103  
826.30B 103,114,130  
826.30C 119,130  
826.30D 114  
826.30E 103  
826.30F 154  
828.40 151  
829.100 151  
830.10 141  
832.28 107,113  
833.20 113  
834.11 113  
836.26 100,112  
842.30 148  
843.22 149  
844.24 149  
845.27 149  
846.25 149  
847.24 148  
850.40 113  
851.30 114,124,132  
851.40 114,124  
855.25 155  
DR 2116.3 180,182  
DR 2203.3 180,182  
L1.03.32 145  
L1.04.35 145  
L1.05.36 145  
MS 2116.1 180,181,182  
MS 2203.1 180,181,182  
MS 3.28 115,132  
MS 4.28 115  
MS 5.20 115  
MS 5.25 115  
MS 6.25 115  
MS 6.32 115  
MS 6.38 115  
MS 7.25 115,132  
NG 2116.2A 180,182  
NG 2203.2A 180,182  
PS 2116.5/100 181,182  
PS 2116.5/80 181,182  
PS 2203.5/60 181,182  
PS 2203.5/80 181,182  
RE 2116.4 180,182  
RE 2203.4 180,182  
TA 2090-92 SET 168  
U1.150 144  
U10/15 53  
U11.001/35 86  
U11.001/50 86  
U11.003 85  
U11/14 53,81  
U12AC 86  
U12AE 86  
U2.135 144  
U2.140 144  
U2.150 144,152  
U3.150 144  
U6.137/45 87  
U6.56/45 87  
U7.180/40 85  
U9.175/55 87,123  
U9.41/41 87,123

a

# aluminium products



# izdelki iz aluminija

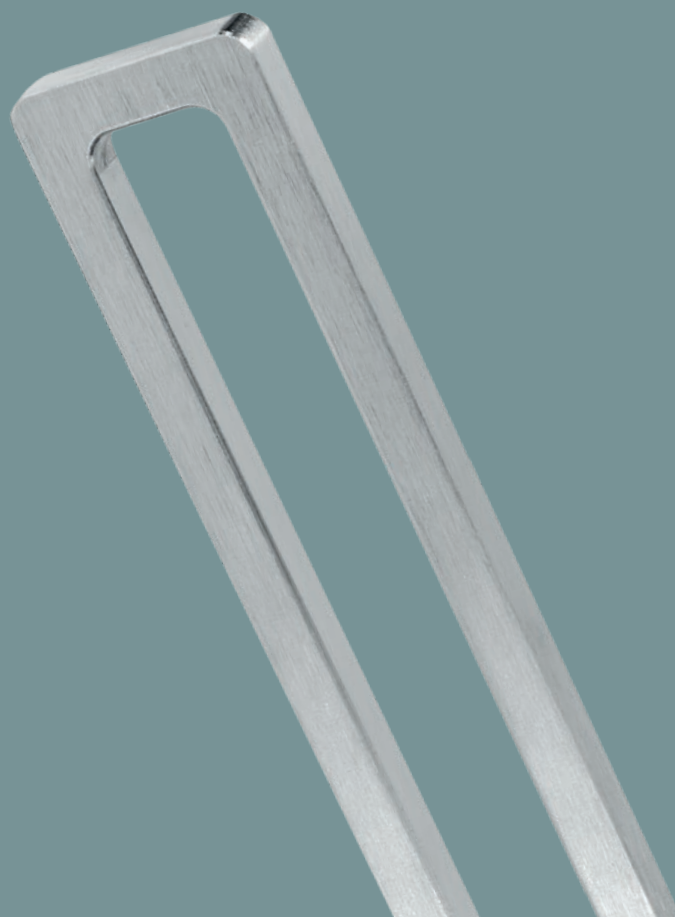

**520.28**

	160	224	256	320	416			26
	167	231	263	327	423			28

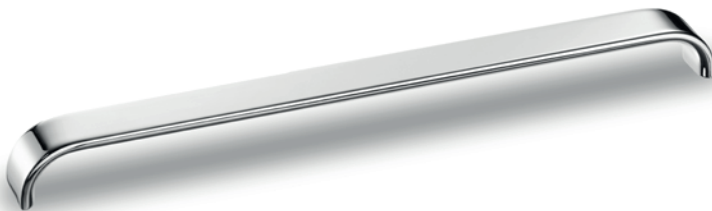
**520.20**

	128	160	224	270	320	370	416	470	620			26
	135	167	231	277	327	377	423	477	627			20

**520.15**

	128	160	224	320	416			26
	135	167	231	327	423			15



595.28



	96	256	352	X		30
	120	300	400	LX		28

595.28B



	96	X
	155	LX
	30	
	28	



NOVO  
NEW

698.20



	160	224	320	416	480	X		28
	168	232	328	424	488	LX		20





574.10



	128	160	224	320	416			32
	138	170	234	330	426			10

NOVO  
NEW

573.15



	128	160	224	320	416			32
	135	167	231	327	423			15



573.20



	128	160	224	256	320	416	480			32
	135	167	231	263	327	423	487			20

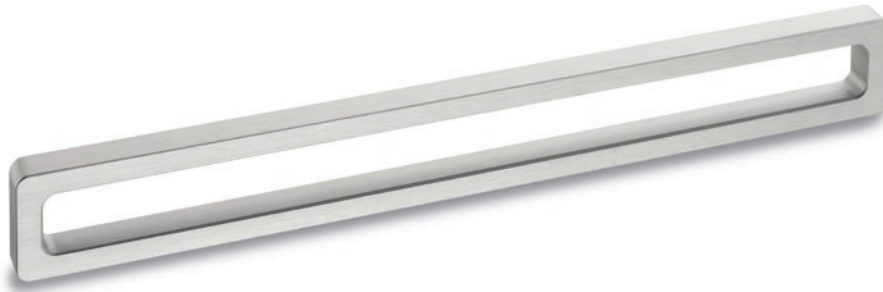

678.12









	160	224	256	320	480			35
	280	330	380	480	580			12



619.10



	160	270	370			36
	197	307	407			10



618.15









	96	160	192			25
	155	211	287			15



653.15



	16	
	35	
	25	
	15	

**673.22**

160

192

224

320

416



29



182

214

246

342

438



22

**620.20**

160

192

256

270

320

370

416

470

620



29



186

218

282

296

346

396

442

496

646



20

**638.27B**

160

224



27



177

239







13



614.16



	160	175	224	275	320	325	375	416	425	475	512	620			35
	186	201	250	301	346	351	401	442	451	501	538	646			16



634.10



	128	160	224	256	320	416	470			29
	150	182	246	278	342	438	492			10

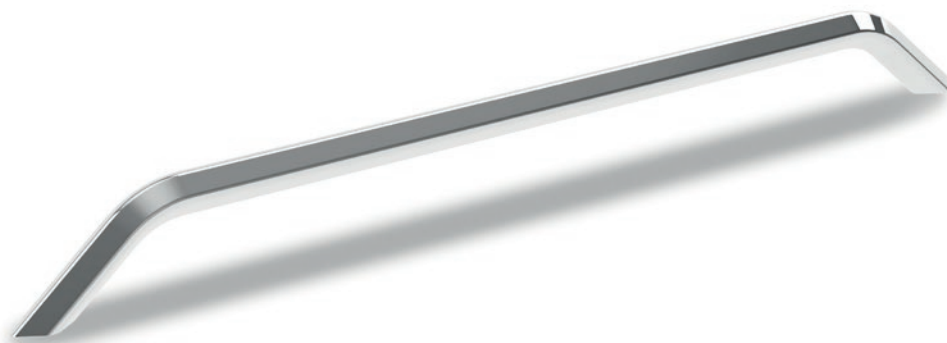

688.12



	160	224	320	416	512	620			33
	185	249	345	441	537	645			12

**570.80**

	32		26
	80		80

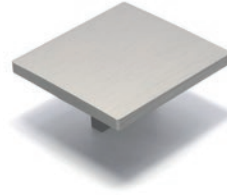
**570.60**

	16		26
	60		60

**570.40**

	16	32	96	128	160	224	288	320	352			26
	40	70	142	192	242	292	342	392	492			40

**525.27**

	32	128	160	192	224	256	288	3x192	3x256			27
	66	175	240	275	325	375	475	675	875			7









341.13		128	160	256	384	512	(X)		43
		141	173	269	397	525	(LX)		13
341.10		128	160	256	384	(X)			32
		138	170	266	394	(LX)			10



640.10		160	224	320	416	480	(X)		30
		170	234	330	426	490	(LX)		10



632.27B		160	224	320	416	(X)			27
		200	260	360	460	(LX)			7



**424.29**

	128	170	192	220	270	320	370	470			29
	143	185	207	235	285	335	385	485			17

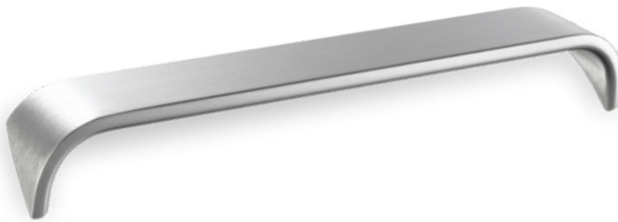
**617.33**

	160	224	320	416			30
	167	231	327	423			33

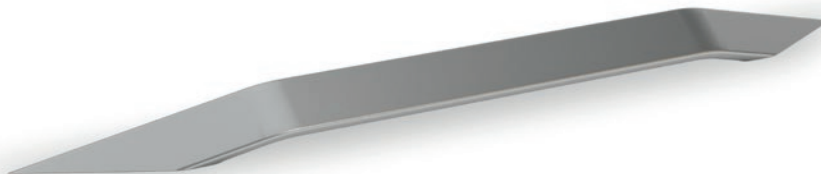
**642.20**

	160	192	256	270	370	416	470			28
	232	264	328	342	442	488	542			20



644.16



	128	160	224	270	320	370	420	470	570	670	770	870			32
	141	173	237	283	333	383	433	483	583	683	783	883			16



581.28



	128	160	224	320	416	480			30
	136	168	232	328	424	488			28



528.02



	224	320	420	520			28
	233	329	429	529			40



648.17



	128	160	224	320	416			17
	160	210	260	360	460			30



513.10B



	192	224	416		29	35	37
	204	233	430		10		



553.28



	224	384		24	34
	239	405		28	



534.25



	170	270	320	370	470	620			23
	200	300	350	400	500	650			23



646.32



	160	210	260	310	360	460			32
	172	222	272	322	372	472			12



426.25



	128	170	192	220	270	320	370	470			25
	143	185	207	235	285	335	385	485			24



NOVO  
NEW

708.15



	64	96	128	160			26
	200	250	300	350			15





631.22A		160	256	384		25
		212	340	470		22



631.22B		192	288	416		29
		215	340	465		22

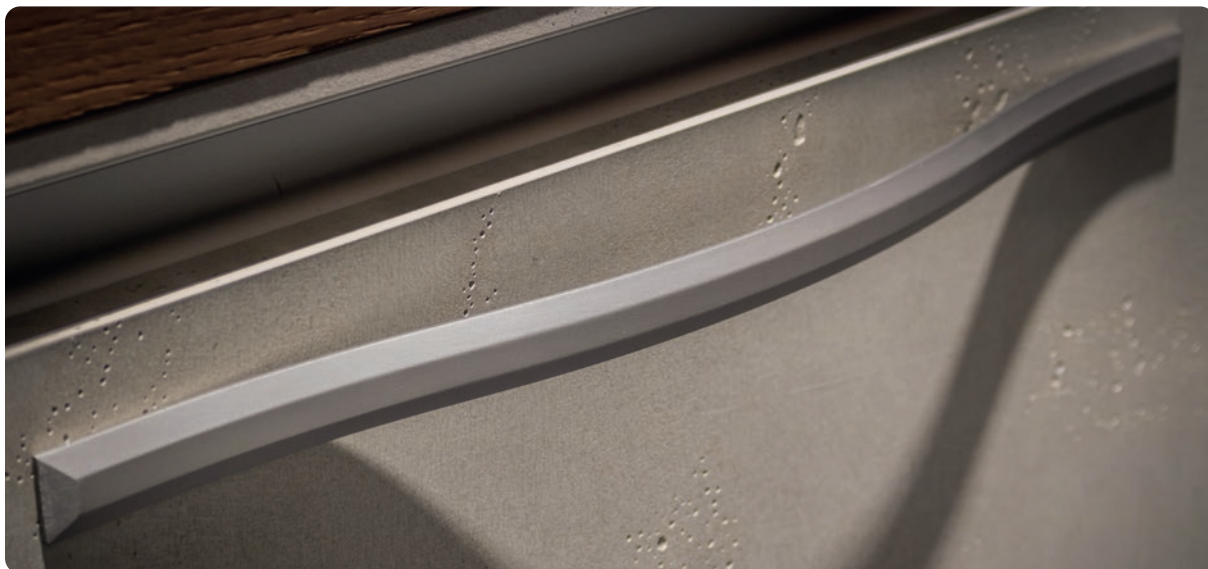



651.24



	32	96	160	(X)		20
	110	180	250	(LX)		24

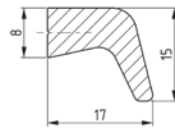

683.15



	32	128	192	224	256	320	448	512	640	(X)		17
	90	190	290	340	390	490	590	690	790	(LX)		15

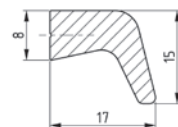

682.15



	64	160	224	256	320	416	488	576	672	(X)		17
	97	197	297	347	397	497	597	697	797	(LX)		15

**550.10**

	128	160	192	224	320	416	480			34
	138	170	202	234	330	426	490			10

**627.10**

	128	184	284	334	384	484	2x342	2x392	2x442	2x542			32
	138	194	294	344	394	494	694	794	894	1094			10

**546.12****546.12B****546.12 / B**







	128	160	192	224	320	416	512	608	800	992			33
	140	172	204	236	332	428	524	620	812	1004			12





476.15



	170	270	320	370	470			38
	181	281	331	381	481			15



347.20



	160	224	305	355	416	505			30
	170	234	315	365	426	515			20



369.16



	128	170	270	320	370	470	670	770	870	1070			37
	153	195	295	345	395	495	695	795	895	1095			16



NOVO  
NEW

713.12



	128	160	224	320	416	512	640			33
	183	215	279	375	471	567	695			12



561.20



	1	64	110	160	210	260	360	560	660	760	960			29
	100	164	210	260	310	360	460	660	760	860	1060			20



693.20



	10	120	150	170	270	370	470	570	770			28
	100	200	250	300	400	500	600	700	900			20



NOVO  
NEW

<b>715.13B / C</b>		128	192	256	352	512	704	928	(X)		35			
		178	210	306	402	562	754	978	(LX)		13			
<b>715.13D</b>		96	128	192	256	(X)		35	<b>715.13/1</b>		1	(X)		22
		170	230	340	460	(LX)		13			13	(LX)		13





NOVO  
NEW

<b>285.13 / B</b>		96	128	192	320	(X)		31
		103	135	199	327	(LX)		13



<b>572.35</b>		128	160	192	256	320	480	640	800	(X)		35
		148	180	212	276	340	500	660	820	(LX)		15







208.10 / B / C		64	96	128	160	192	224	320	416	608	800	992			29	30	32
		100	134	178	210	242	274	370	466	658	850	1042			10		

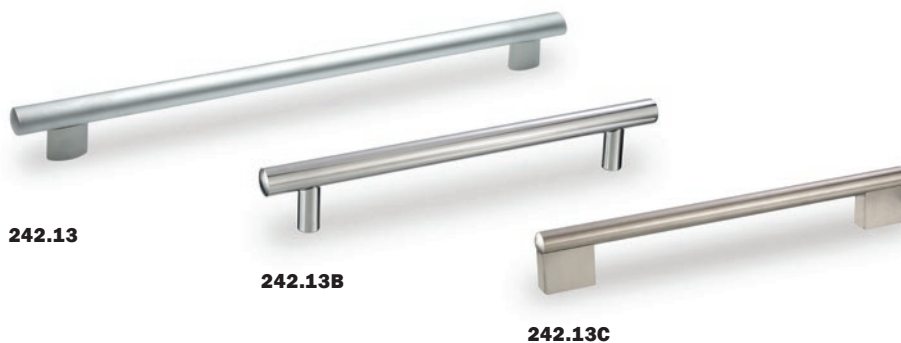

624.12BL / CL		128	160	192	224	256	288	384	480	576	672			34
		178	210	242	274	306	338	434	530	626	722			12
679.12L		128	160	192	224	256	288	384	480	576	672			34
		168	200	232	264	296	328	424	520	616	712			12









242.13 / B / C		128	160	192	256	352	512	704	928			31	33	34
		178	210	242	306	402	562	754	978			13		









611.08











611.08B

611.08 / B		32	96	160	224	320	2x224	2x320	2x416			28
		96	224	288	352	448	576	768	960			8



612.08		64	160	224	320	2x224	2x320	2x416			31
		79	175	239	335	463	655	847			10



404.16												41
												16
404.16 / B		128	160	256	352	448	544	768	1056			
		178	210	306	402	498	594	818	1106			

404.16B		36
		16

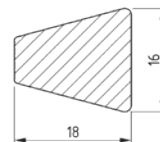

NOVO  
NEW

709.16



	16	64	96	128	160	192	224	320	416	800			18
	45	100	150	200	250	300	350	400	500	1090			16

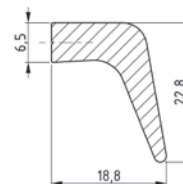

567.19



	1	32	64	96	128	160	224	320	416	544			23
	20	40	95	116	145	180	295	395	495	795			19



490.17





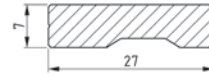

	1	128	160	224	320	416	2x336			17
	20	178	210	295	360	495	695			10



613.27B





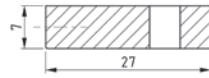
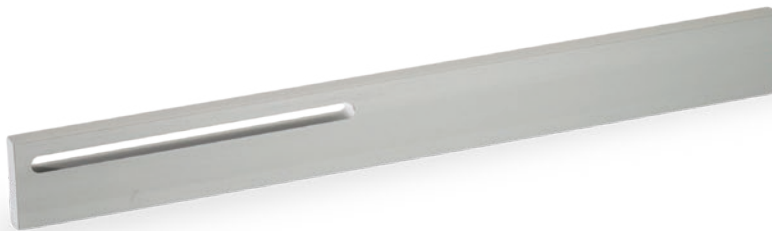

	16	128	160	224	320	(X)		27
	32	160	224	320	416	(LX)		7



427.27





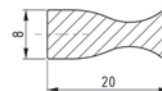

	96	128	160	(X)		27
	150	200	250	(LX)		7







670.20

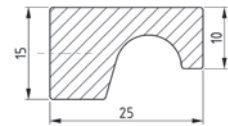
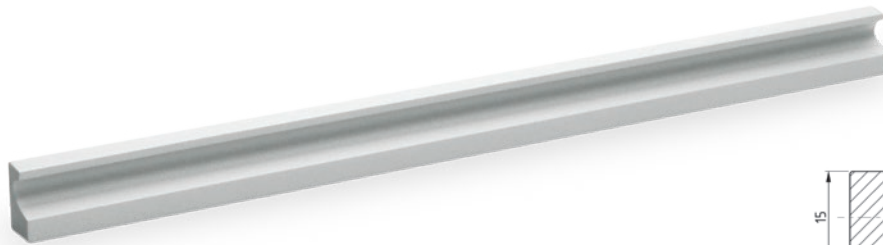





	64	(X)		20
	80	(LX)		8

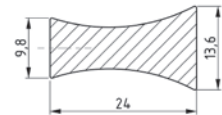





357.25		224	320	400	2x288	2x352	2x384	(K)		25
		250	383	500	600	788	833	(LX)		15

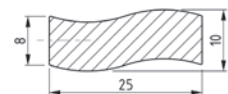

375.24		32	64	96	128	160	192	320	(K)		24
		52	82	114	148	178	210	338	(LX)		14



390.25		32	96	160	192	288	512	(K)		25
		40	114	178	210	306	668	(LX)		10



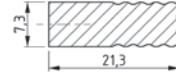

374.21



	96	128	160	192	320	512	608	800	(X)		21
	114	146	178	210	466	668	860	1052	(LX)		7

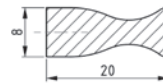

410.20



	32	64	96	128	160	192	288	2x400	2x448	2x480	(X)		20
	52	82	114	168	210	242	328	854	954	1000	(LX)		8

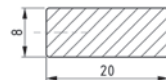





333.08

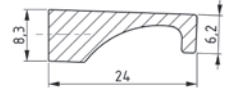





	1	96	128	160	256	320	512	608	800	(X)		20
	30	105	168	242	370	466	668	860	1052	(LX)		8

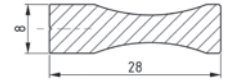
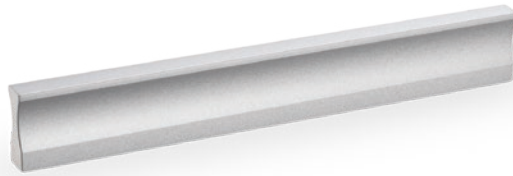



531.24		32	64	160	192	2x112	2x144	2x160	2x208	2x192	2x272	2x400	(X)		24
		52	85	200	255	300	350	400	500	565	800	1100	(LX)		8

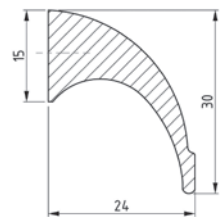
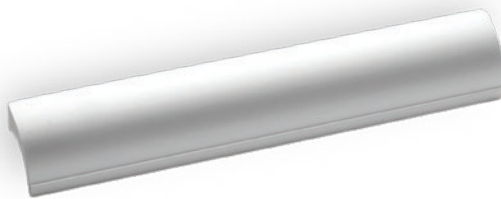

576.28		64	2x96	224	2x192	2x448	(X)		28
		84	250	300	450	1020	(LX)		8



327.24		128	160	224	320	416	512	608	(X)		30
		150	210	295	395	495	595	695	(LX)		24

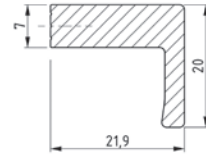

**328.20B**



	1	96	128	160	192	224	320	416	512	672	736	800	
	20	120	178	210	242	295	395	495	595	695	795	895	

	22
	20

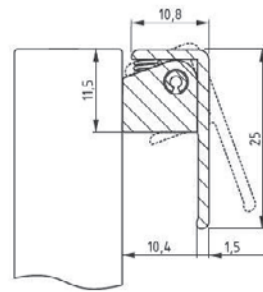
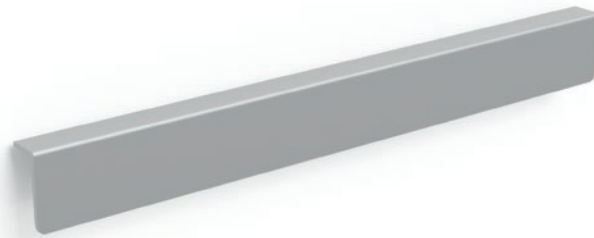

**675.25**



	32	32	106(170)	156(220)	206(270)	256(320)	306(370)	256(420)	
	60	147	197	247	297	347	397	447	
	406(470)	456(520)	506(570)	606(670)	706(770)	806(870)	906(970)	1106(1170)	
	497	547	597	697	797	897	997	1197	

	25
	11
	25
	11





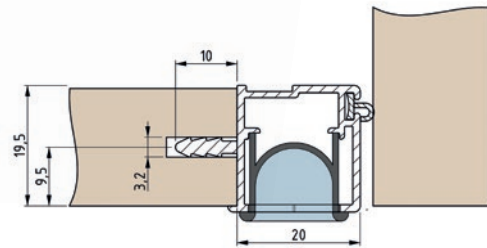
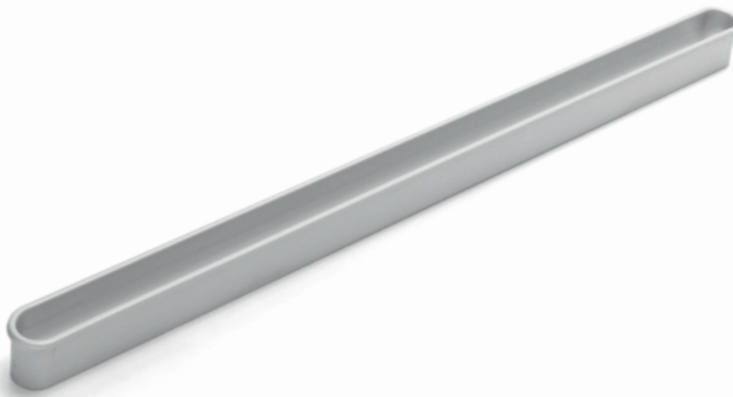

**U10/15**



300



**2168**



2750 (1833)

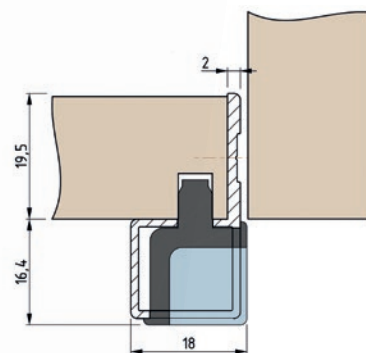

**U11/14**



298



**2169**



2750 (1833)





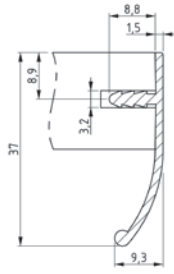

**325.37**



2750 (1833)

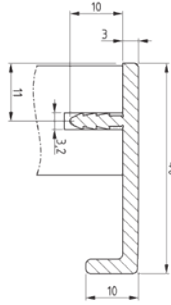

**10.002**



2750 (1833)

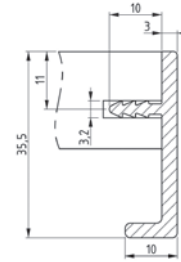

**555.95**



2750 (1833)

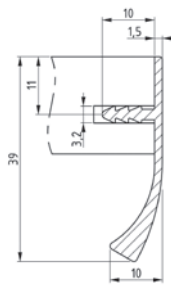

**2192**



2750 (1833)

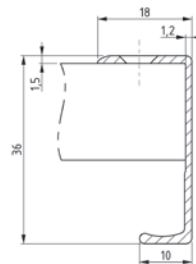

**658.35**



2750, 2300, (1833)

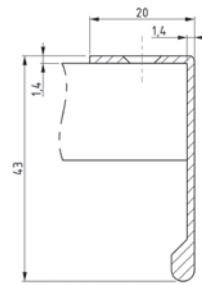

**466.43**



2750 (1833)

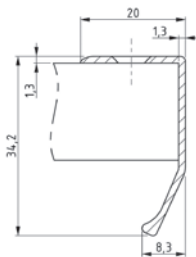

**643.33**



2750 (1833)

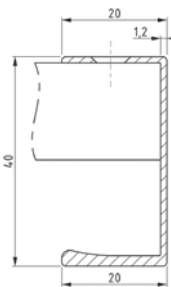

**606.40**



2750 (1833)

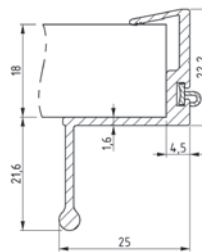

**444.25**



2750 (1833)

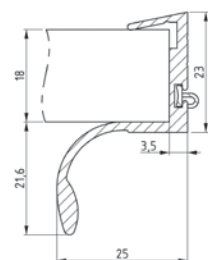

**445.25**



2750 (1833)

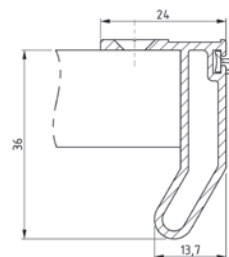

**2107**



2750 (1833)

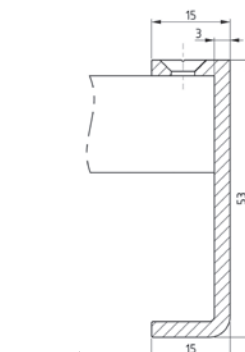

**552.15**



2750 (1833)









665.12

684.12

525.27

561.20

568.28

665.12

(a)



864



1090



33



12

684.12

(a)



864



1090



33



12

525.27

(a)



2x400



1100



27



7

561.20

(a)



960



1060



29



20

568.28

(a)



882



927



30



28





NOVO  
NEW

NOVO  
NEW

NOVO  
NEW



697.14B



697.14C



690.16



693.20



708.15

697.14B

(a)

	2x540
	1100
	14
	18

697.14C

(a)

	2x540
	1100
	14
	18

690.16

(a)

	2x352
	1100
	22
	16

693.20

(a)

	770
	900
	28
	20

708.15

(a)

	2x448
	1100
	26
	15





a



520.20C



20



574.10C



10



632.27BC



7

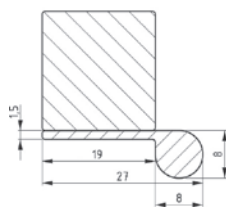

**616.08**

a

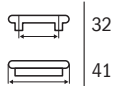

32

41

**616.08B**

a

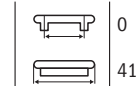

0

41



**2109A**



	160	256	352	448	544	768	1056	
	211	307	403	499	595	819	1107	
	42+42							
	16							



**2188**



	40
	30



**2144**



	192
	208
	26+26
	16



**2189**



	256
	292
	45+45
	15



a





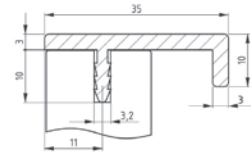

555.95  
555.97



145	195	245	295	345	395	445	495	545	595	695	795	895	995	1095	1195	LX
147	197	247	297	347	397	447	497	547	597	697	797	897	997	1097	1197	LX

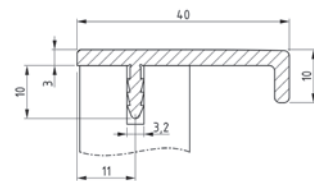

NOVO  
NEW

10.002



147	197	247	297	347	397	447	497	547	597	697	797	897	997	1097	1197	LX
-----	-----	-----	-----	-----	-----	-----	-----	-----	-----	-----	-----	-----	-----	------	------	----

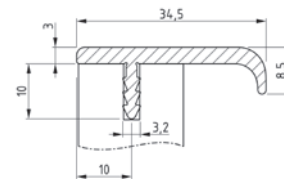
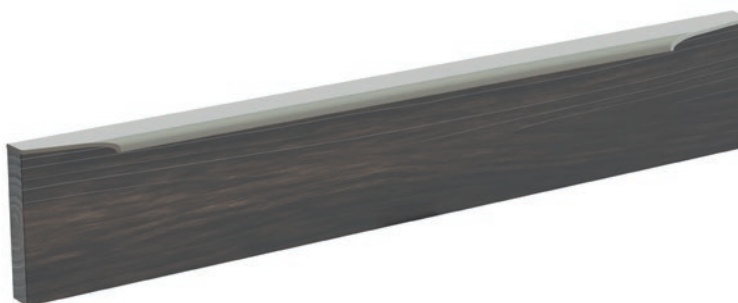

NOVO  
NEW

10.003



146	196	246	296	346	396	446	496	546	596	696	896	996	1196	LX
-----	-----	-----	-----	-----	-----	-----	-----	-----	-----	-----	-----	-----	------	----



2192

a



147 | 197 | 247 | 297 | 347 | 397 | 447 | 497 | 547 | 597 | 697 | 797 | 897 | 997 | 1097 | 1197 | (LX)

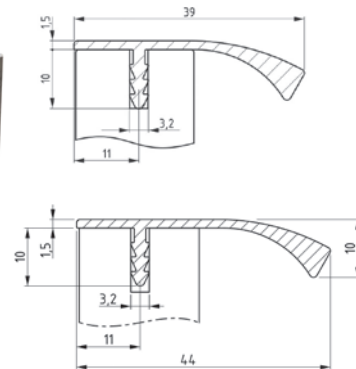

2222

a



147 | 197 | 247 | 297 | 347 | 397 | 447 | 497 | 547 | 597 | 697 | 797 | 897 | 997 | 1097 | 1197 | (LX)

2192B

a



147 | 197 | 247 | 297 | 347 | 397 | 447 | 497 | 547 | 597 | 697 | 797 | 897 | 997 | 1097 | 1197 | (LX)

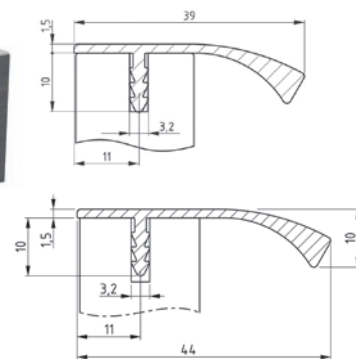

2222B

a



147 | 197 | 247 | 297 | 347 | 397 | 447 | 497 | 547 | 597 | 697 | 797 | 897 | 997 | 1097 | 1197 | (LX)

2192C

a



147 | 197 | 247 | 297 | 347 | 397 | 447 | 497 | 547 | 597 | 697 | 797 | 897 | 997 | 1097 | 1197 | (LX)

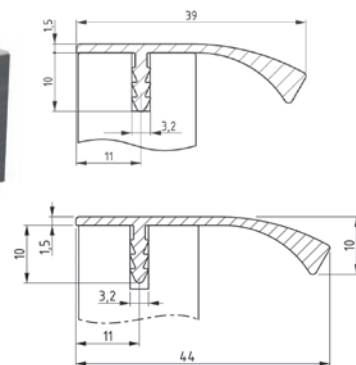

2222C

a



147 | 197 | 247 | 297 | 347 | 397 | 447 | 497 | 547 | 597 | 697 | 797 | 897 | 997 | 1097 | 1197 | (LX)

2192D



147 | 197 | 247 | 297 | 347 | 397 | 447 | 497 | 547 | 597 | 697 | 797 | 897 | 997 | 1097 | 1197 | (Lx)

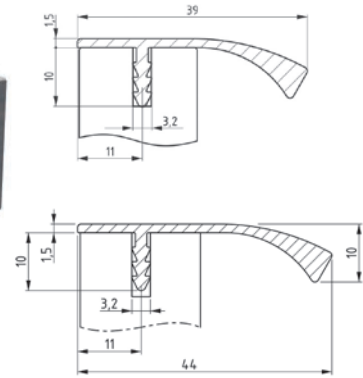

2222D



147 | 197 | 247 | 297 | 347 | 397 | 447 | 497 | 547 | 597 | 697 | 797 | 897 | 997 | 1097 | 1197 | (Lx)

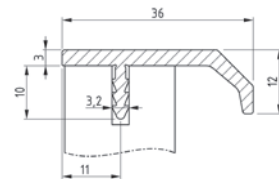

NOVO  
NEW

10.005



147 | 197 | 247 | 297 | 347 | 397 | 447 | 497 | 547 | 597 | 697 | 797 | 897 | 997 | 1197 | (Lx)

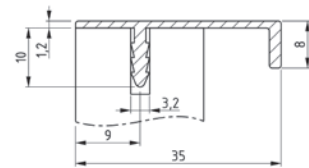

464.35

464.35



152 | 452 | 1052 | 1052 | (Lx)

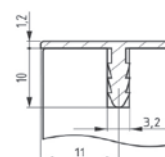

2118

2118



2750 | (Lx)



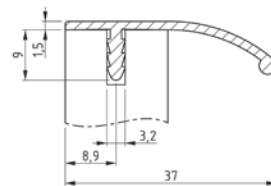

398.37



145

195

245

295

345

395

445

495

545

595

695

795

895

995

1095

1195

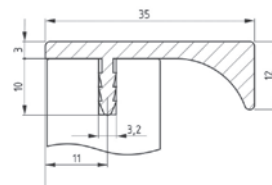

2141



147

197

247

297

347

397

447

497

547

597

697

797

897

997

1097

1197

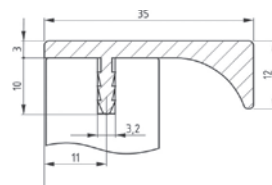

2217



146

196

246

296

346

396

446

496

546

596

696

796

896

996

1096

1196



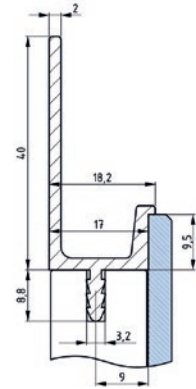

2139



146	196	246	296	346	396	446	496	546	596	696	796	896	996	1096	1196	LX
-----	-----	-----	-----	-----	-----	-----	-----	-----	-----	-----	-----	-----	-----	------	------	----

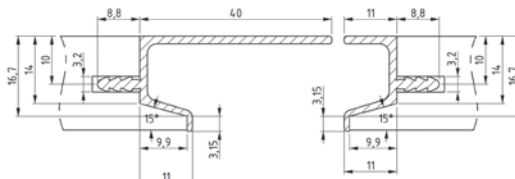
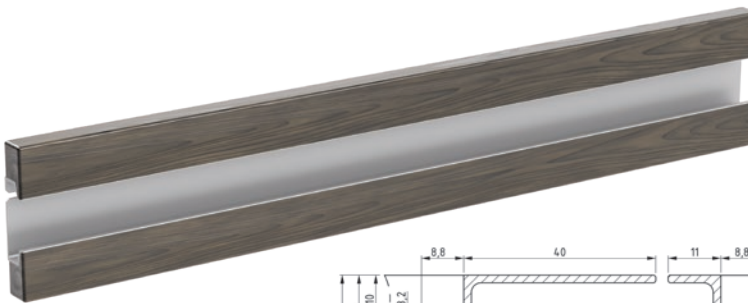

2159B

2159A

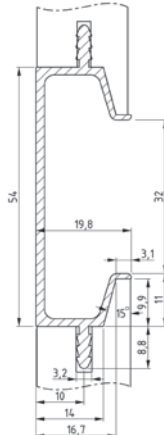

2159C

2159A / B / C



145	195	245	295	345	395	445	495	545	595	695	795	895	995	1095	1195	LX
147	197	247	297	347	397	447	497	547	597	697	797	897	997	1097	1197	LX

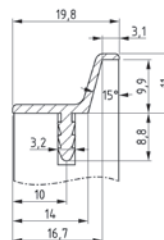

2159D



147	197	247	297	347	397	447	497	547	597	697	797	897	997	1197	LX
-----	-----	-----	-----	-----	-----	-----	-----	-----	-----	-----	-----	-----	-----	------	----

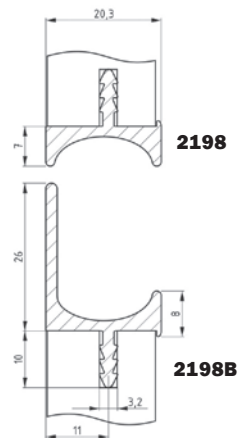
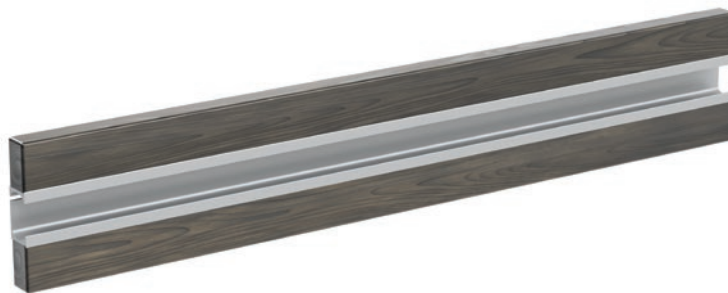

**2198 / B**

147	197	247	297	347	397	447	497	547	597	697	797	897	997	1097	1197	Ⓛ
-----	-----	-----	-----	-----	-----	-----	-----	-----	-----	-----	-----	-----	-----	------	------	---

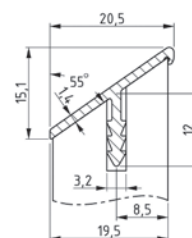
**2197**

147	197	247	297	347	397	447	497	547	597	697	797	897	997	1097	1197	Ⓛ
-----	-----	-----	-----	-----	-----	-----	-----	-----	-----	-----	-----	-----	-----	------	------	---

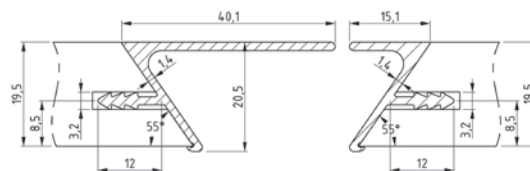
**2197B****2197A****2197A / B**

147	197	247	297	347	397	447	497	547	597	697	797	897	997	1097	1197	Ⓛ
-----	-----	-----	-----	-----	-----	-----	-----	-----	-----	-----	-----	-----	-----	------	------	---



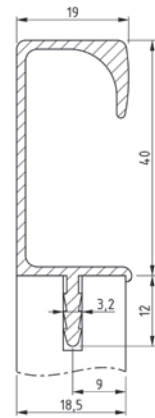

401.40



145 | 195 | 245 | 295 | 345 | 395 | 445 | 495 | 545 | 595 | 695 | 795 | 895 | 995 | 1095 | 1195 | LX

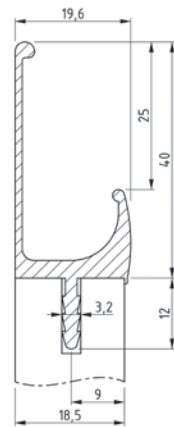

345.18



145 | 195 | 245 | 295 | 345 | 395 | 445 | 495 | 545 | 595 | 695 | 795 | 895 | 995 | 1095 | 1195 | LX

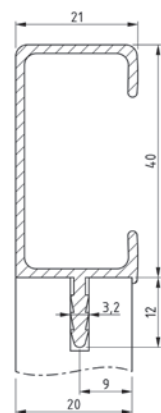
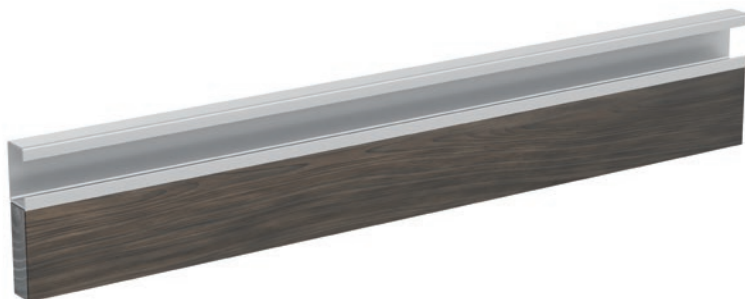

452.21



145 | 195 | 245 | 295 | 345 | 395 | 445 | 495 | 545 | 595 | 695 | 795 | 895 | 995 | 1095 | 1195 | LX



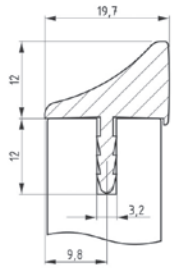

441.97



147	197	247	297	347	397	447	497	547	597	697	797	897	997	1097	1197	Ⓛ
-----	-----	-----	-----	-----	-----	-----	-----	-----	-----	-----	-----	-----	-----	------	------	---

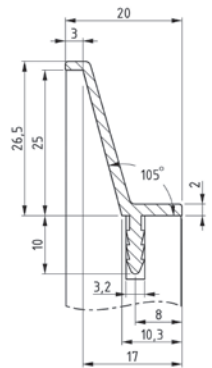
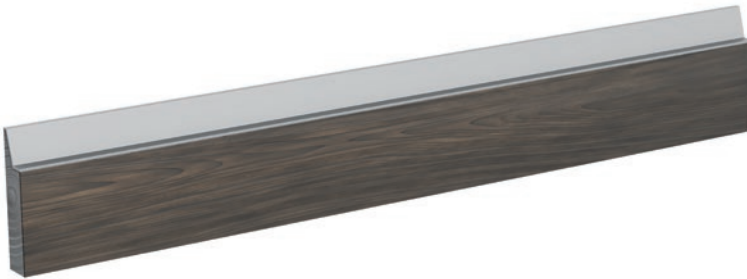

2142



146	196	246	296	346	396	446	496	546	596	696	796	896	996	1096	1196	Ⓛ
-----	-----	-----	-----	-----	-----	-----	-----	-----	-----	-----	-----	-----	-----	------	------	---

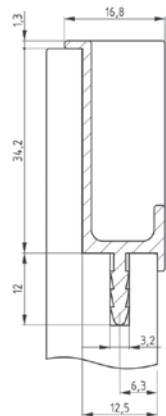
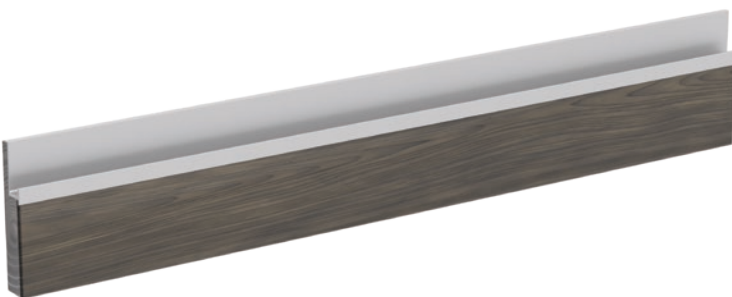

326.15B



145	195	245	295	345	395	445	495	545	595	695	795	895	995	1095	1195	Ⓛ
-----	-----	-----	-----	-----	-----	-----	-----	-----	-----	-----	-----	-----	-----	------	------	---





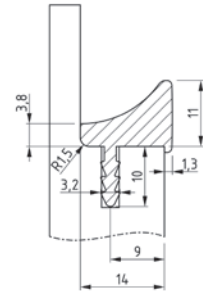

10.001



147 | 197 | 247 | 297 | 347 | 397 | 447 | 497 | 547 | 597 | 697 | 797 | 897 | 997 | 1097 | 1197 | (Lx)

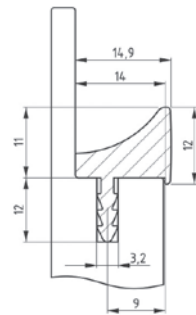

10.001B



100 | 200 | 350 | (Lx)

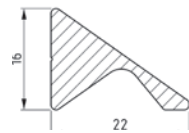

690.16



64 | 96 | 128 | 160 | 192 | 224 | 256 | 288 | 320 | 352 | (X)



140 | 190 | 240 | 290 | 340 | 390 | 440 | 490 | 540 | 590 | (Lx)

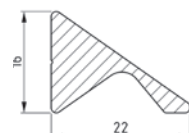
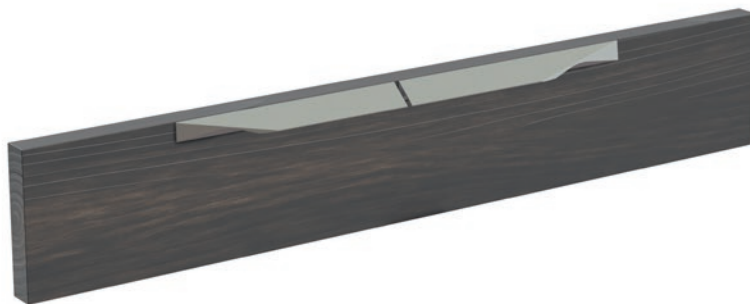

NOVO  
NEW

690.16L (R)



64 | 96 | 128 | 160 | 192 | 224 | 256 | 288 | 320 | 352 | (X)





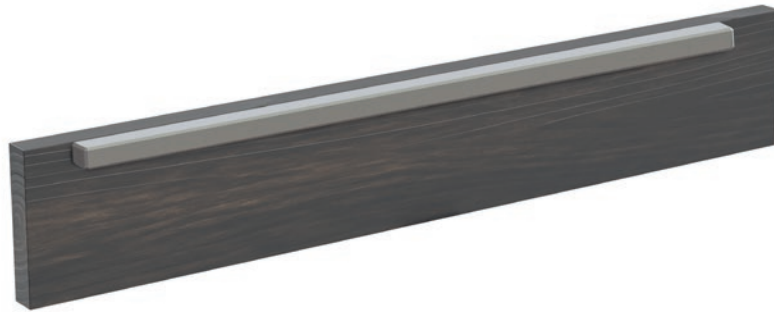



140 | 190 | 240 | 290 | 340 | 390 | 440 | 490 | 540 | 590 | (Lx)

NOVO  
NEW

697.14B





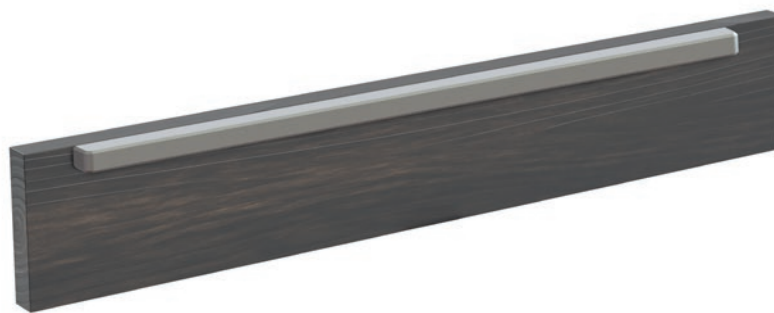
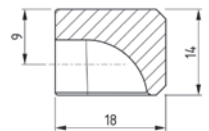

a

	96	128	160	224	280	320	380	430	480			18
	116	150	200	250	300	350	400	450	500			14

NOVO  
NEW

697.14C

a

	96	128	160	224	280	320	380	430	480			18
	116	150	200	250	300	350	400	450	500			14

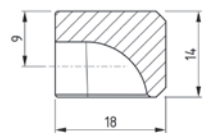







kolpa-san

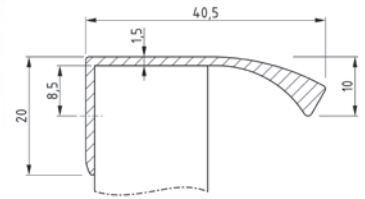

kolpa-san



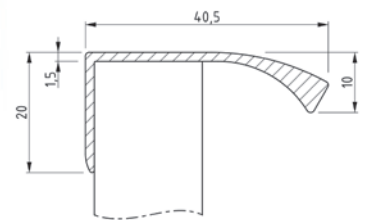

**12.002A**

a

	147	197	247	297	347	397	447	497	547	597	697	797	897	997	1197	
	64	128	192	192	224	288	320	2x192	2x224	2x256	2x288	3x224	3x256	3x288	3x352	



NOVO  
NEW**12.002B**

a

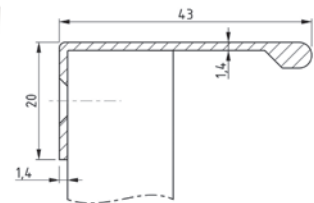
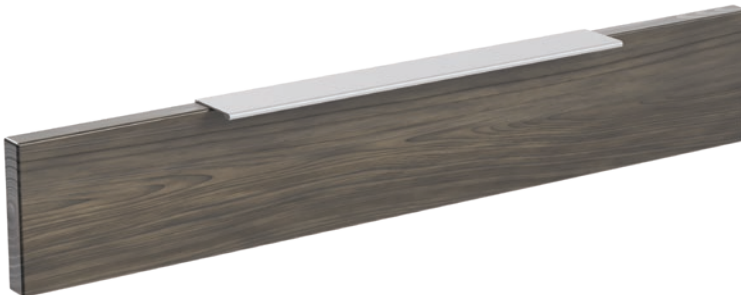
	147	197	247	297	347	397	447	497	547	597	697	797	897	997	1197	
	64	128	192	192	224	288	320	2x192	2x224	2x256	2x288	3x224	3x256	3x288	3x352	

**466.43**

a

	40	200	2750	
	32	128	0	



kolpa-san



kolpa-san

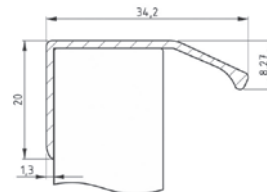

656.35



	147	197	247	297	347	397	447	497	597	697	797	897	997	1097	1197	<input checked="" type="checkbox"/>
	100	140	190	220	260	300	2x195	2x220	2x260	2x300	3x240	3x270	3x290	3x320	3x350	<input checked="" type="checkbox"/>

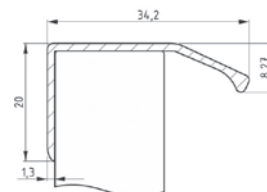

643.33



	45	90	160	200	<input checked="" type="checkbox"/>
	16	64	128	160	<input checked="" type="checkbox"/>

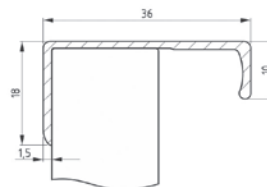

658.35



	50	90	200	<input checked="" type="checkbox"/>
	32	64	160	<input checked="" type="checkbox"/>

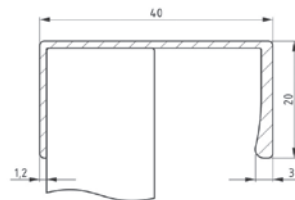

606.40



50 200 350 500

LK

a



32 160 288 2x224

K

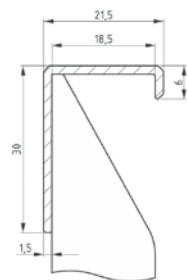
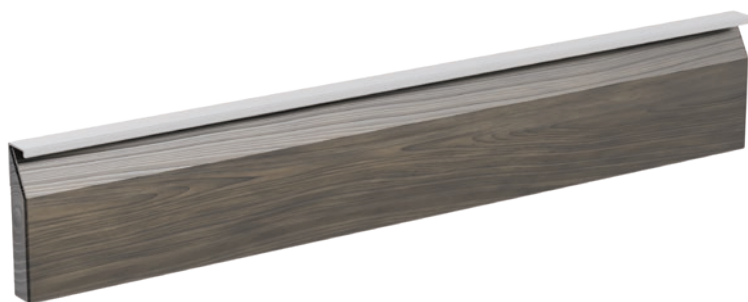

609.18



147 247 297 347 397 447 497 597 797 897 997 1097 1197

LK

a



100 190 220 250 250 220/400 220/450 220/540 220/720 220/800 200/900 220/1000 220/1000

K

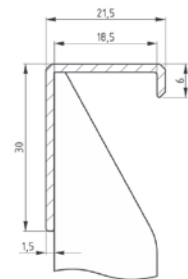
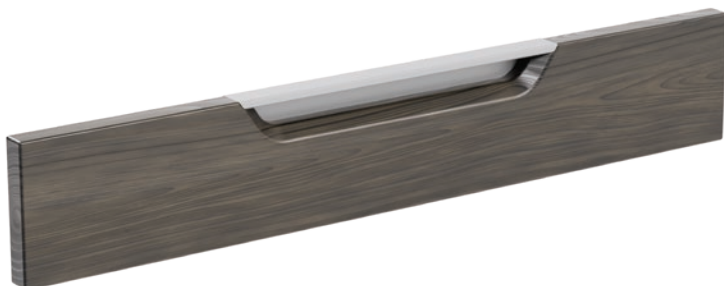

609.18D



170 270 470

LK

a



150 250 450

K

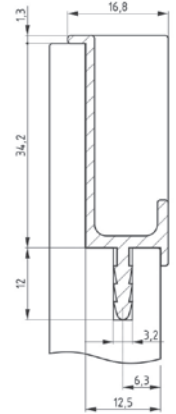

326.15



108

140

172

204

236



96

128

160

192

224

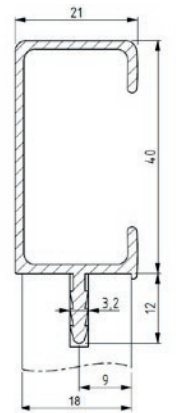

455.18



164

264

314

364

464

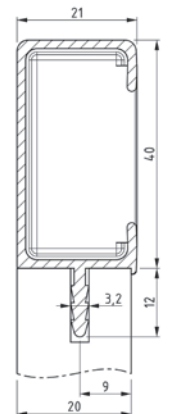

433.21



164

264

314

364

464





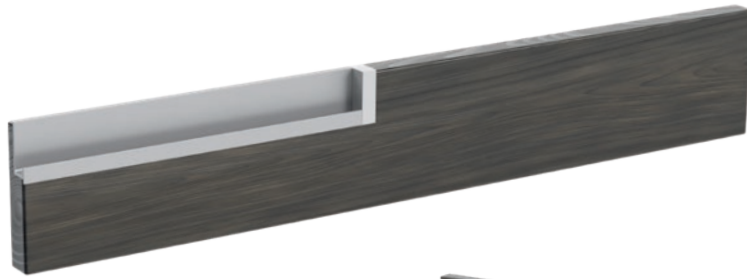

326.15D

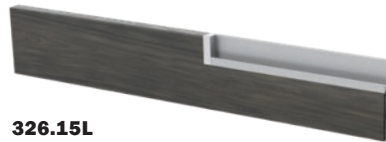

326.15L

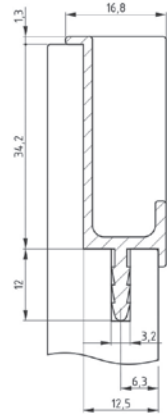

326.15L (D)



1090



U11/14



2x128



298

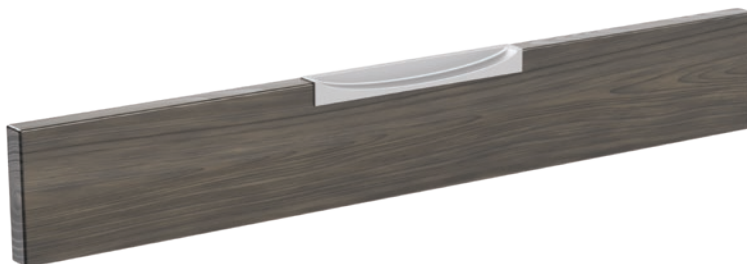

586.14



96



170

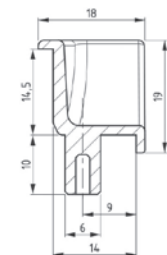
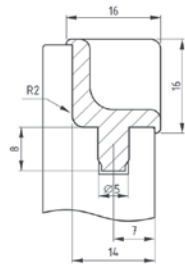

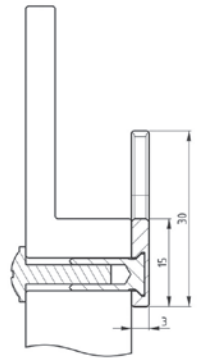
**2171**

360

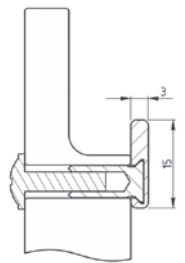

2x160

**674.15**

197

247

297

347

397

447

497

597

697

797

897

997

1097

1197



120

2x85

2x110

2x135

2x160

2x185

2x210

4x130

4x155

4x180

4x205

4x230

4x255

4x280

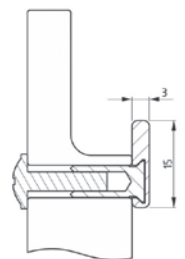
**674.15B**

101

197

347



64

2x80

2x160



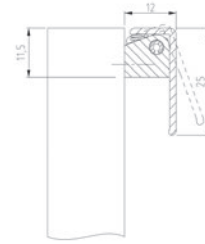
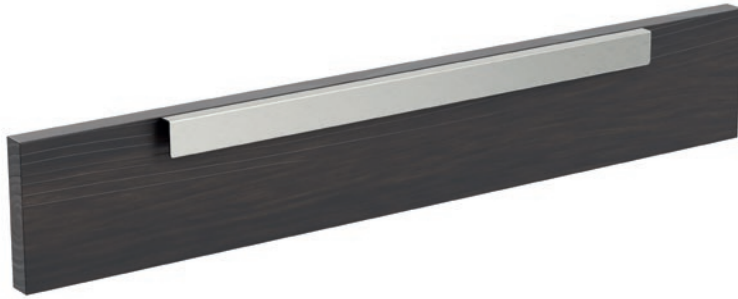

**675.25**



	60	147	197	247	297	347	397	447	
	32	32	106(170)	156(220)	206(270)	256(320)	306(370)	256(420)	
	497	547	597	697	797	897	997	1197	
	406(470)	456(520)	506(570)	606(670)	706(770)	806(870)	906(970)	1106(1170)	

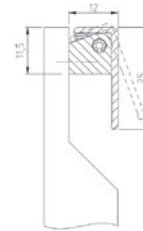

**675.25B**



	198	
	96+ (160)	

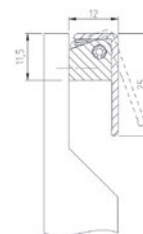

**675.25CL (R)**



	96+(160)	256+(320)	
	199	359	

L - Left, R - Right

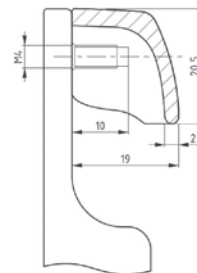

**437.20**

200 250

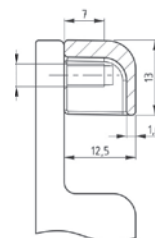

160 224

**615.13**

125

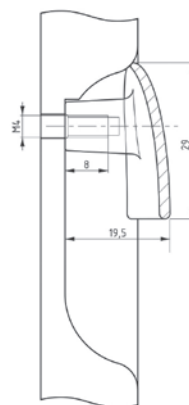

96

**435.30**

162



128

NOVO  
NEW

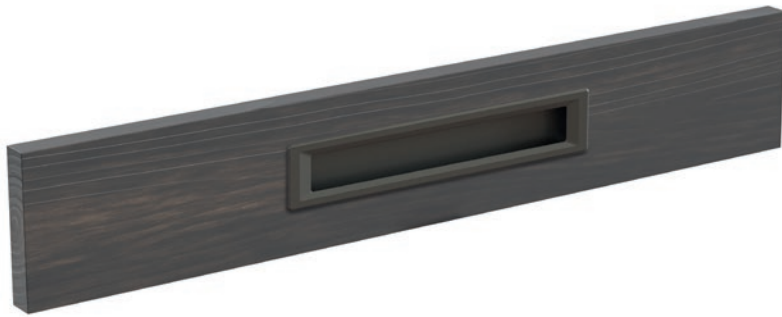

**U11.003**



	192		41
	38x200		14,7
	203		2

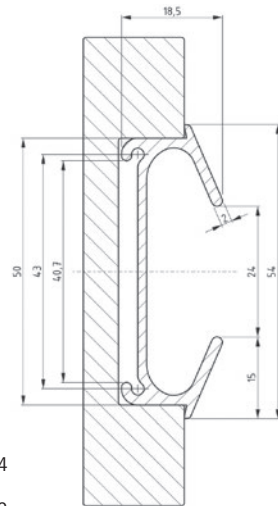

**403.07**



	147	179	211	243	275		54
	128	160	192	224	256		12
	49x137	49x169	49x201	49x233	49x265		7







**U7.180/40**



	160		50
	40x180		15
	192		5





**U11.001/35**

a

	41.7
	f35
	13.5
	2



**U11.001/50**

a

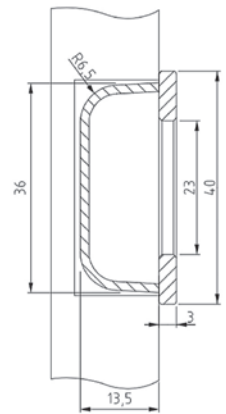
	54.7
	f50
	13.5
	2



**U12AC**

3

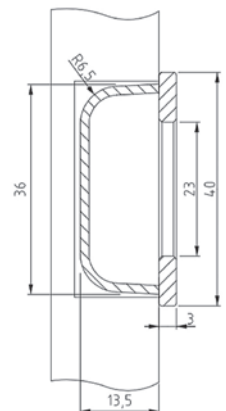
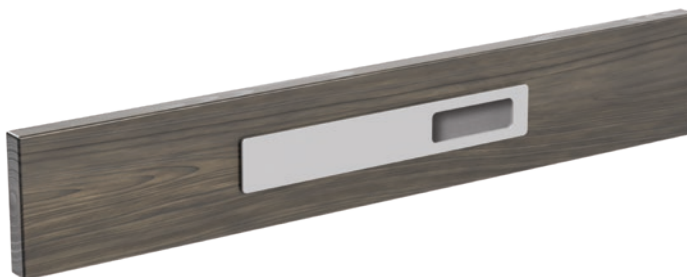
	108	172
	96	160
	36x103,5	36x103,5

**U12AE**

a

	130	180	255
	96	96+(64)	96+(128)
	36x103,5	36x103,5	36x103,5



**U9.175/55**



	160		55
	46x168		13,5
	175		2

**U9.41/41**



	28		41
	fi35		13,5
	41		2



**U6.137/45**



	128		50
	138x46		14
	142		2

**U6.56/45**



	32		50
	57x46		14
	61		2



# GOLA PROFILNI SISTEMI GOLA PROFILE SYSTEMS

a





HORIZONTALNI PROFILI  
HORIZONTAL PROFILES

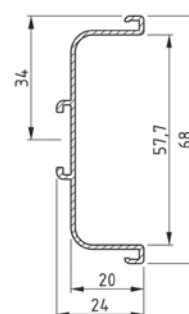
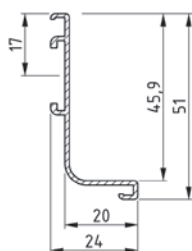
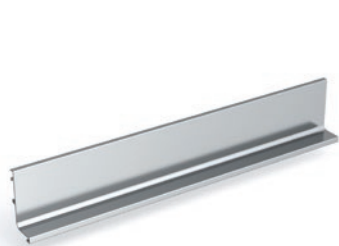
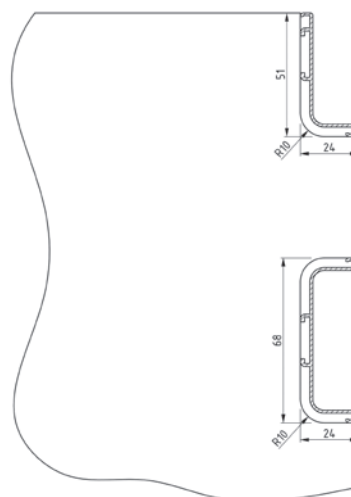

2199L



2199C



MONTAŽNI SISTEMI  
FITTING SYSTEM

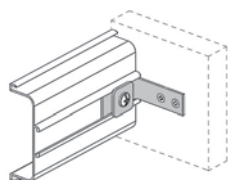

2199K

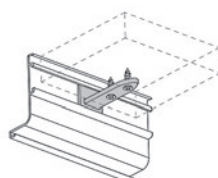

2199T-18 / T-19

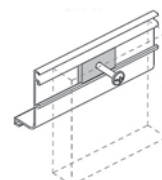

2199P



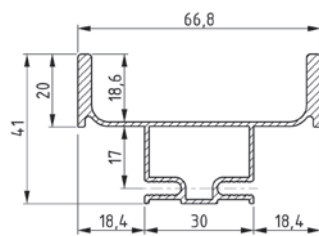
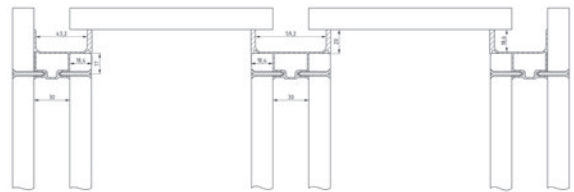
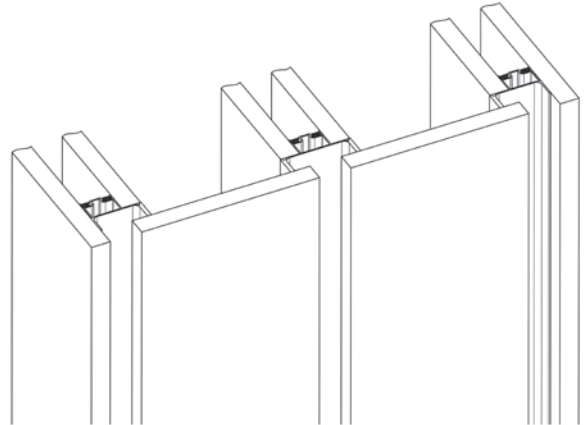

VERTIKALNI PROFILI  
VERTICAL PROFILES

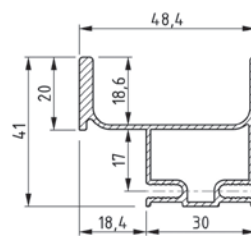
**2200C**  | 4500 | 2400 | 

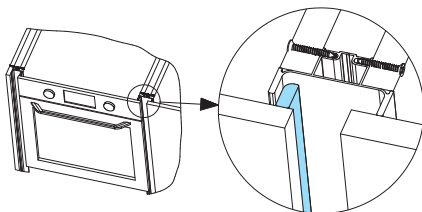

**2200L**  | 4500 | 2400 | 



**2200P**  | 1210 | 



GOLA ZAKLJUČKI  
GOLA CAPS

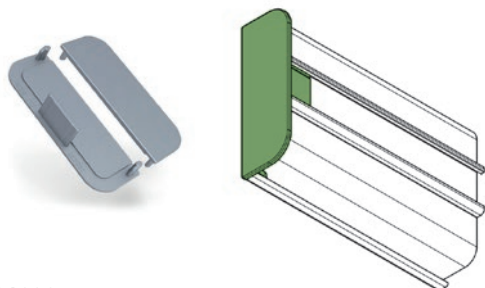

2199C.F

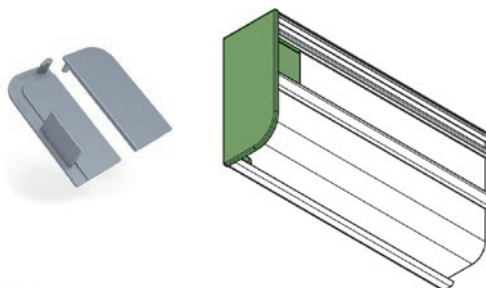

2199L.F

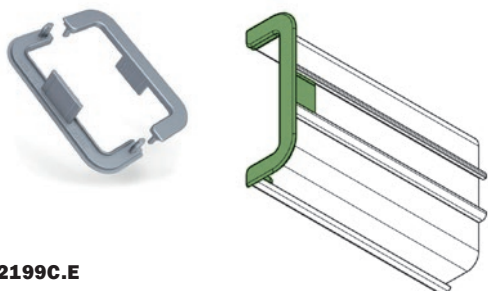

2199C.E

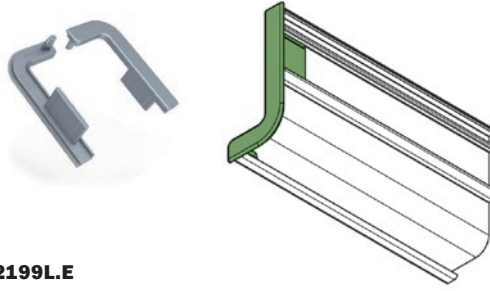

2199L.E

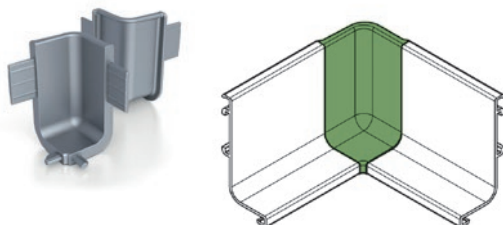

2199L.I

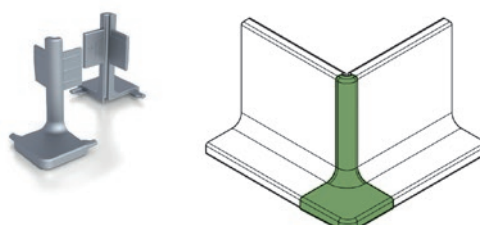

2199L.O

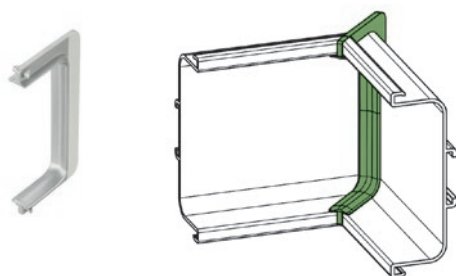

2199C.IS

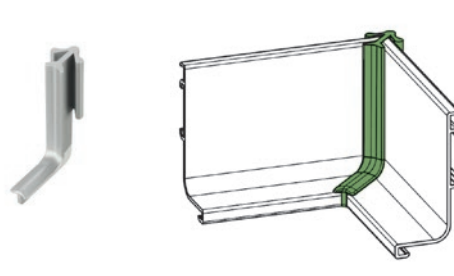

2199L.IS

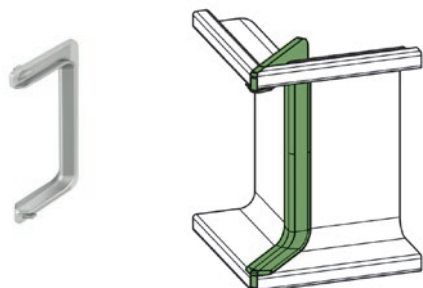

2199C.OS

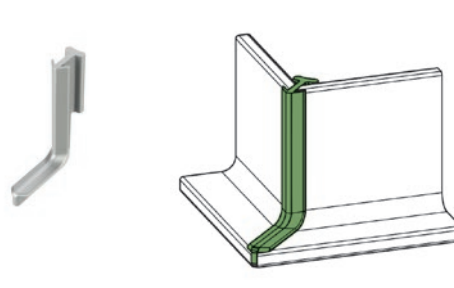

2199L.OS



a





**80.001**

	300	350	400	450	500	600	700	
--	-----	-----	-----	-----	-----	-----	-----	--

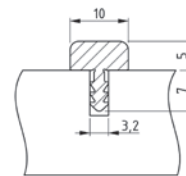

**80.002**

	300	350	400	450	500	600	700	
	200	250	300	350	400	2x224	2x256	

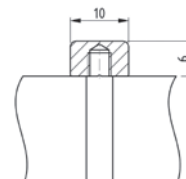

**80.003**

	300	350	400	450	500	600	700	
--	-----	-----	-----	-----	-----	-----	-----	--

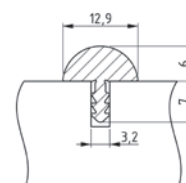

a

1

# metal handles and knobs



# **kovinski ročaji in gumbi**



**691.26**

192



26



228



26

**692.18**

160

320



26



177

337



18

**588.25**

160

224



25



172

236



21





587.25



160 224



25



170 234



15



NOVO  
NEW

696.15



160 224



26



168 232



15



685.10



128 160 224 256 320



30



138 170 234 266 330



10



NOVO  
NEW

**703.14**



	160	224	320		27
	185	249	345		14



NOVO  
NEW

**700.14**



	160	224	320		18
	200	264	360		14

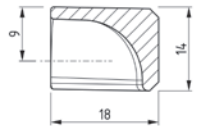



NOVO  
NEW

689.14



160 224



28



170 234



14



NOVO  
NEW

694.16



160 224



27



186 250



16



669.15



160 224 320



26



168 232 328



15





		1	128		29
		28	198		28(20)



		160	224		29
		218	282		15

MADE WITH  
SWAROVSKI  
ELEMENTS



		160	224		26
		172	236		14

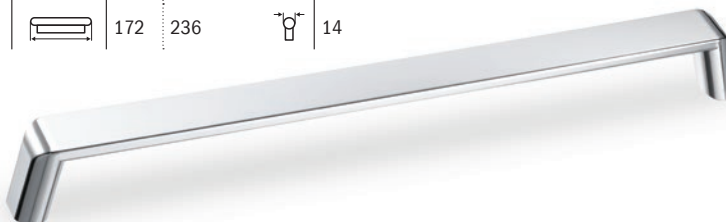

		160	224		26
		172	236		14

		18
		26
		14



354.25



	96	128	192		28	24	28
	115	156	226		25	20	25



677.08



	160		28
	168		8



604.27



	160	224		27
	175	239		26





**415.26R**



96

128

192



27



102

134

198



12



**495.25**



160

192



29



167

224



25



**529.27**



96

128

160

192

256



27



113

150

190

222

286



9



<b>516.30</b>		128	192		24
			170	234	

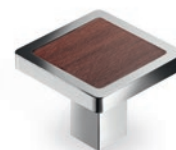

<b>826.30</b>		1	
			30
		24	
		30	

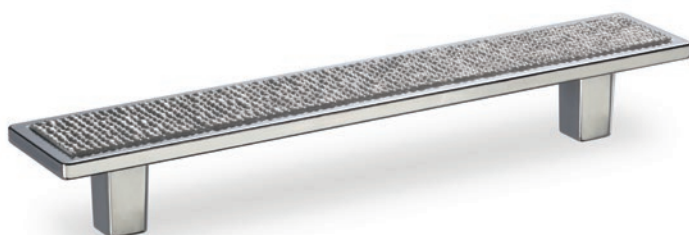

<b>516.30B</b>		128	192		25
			170	234	

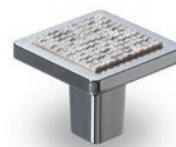

<b>826.30B</b>		1	
			30
		25	
		30	



<b>516.30E</b>		128	192		24
			170	234	



<b>826.30E</b>		1	
			30
		24	
		30	





a



<b>446.24R</b>		128	160	224		25
		159	193	267		15



<b>447.20R</b>		96	128	160		24	25	26
		135	179	211		20	22	24



<b>497.22</b>		160		28
		191		22





**360.28**



160



28



190



15



**367.20**



16



30



21



27



**496.14**



160



29



169



14



**603.29**



160



29



168



11



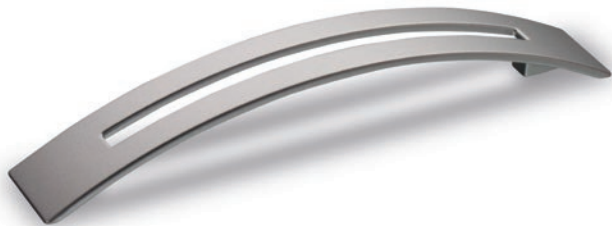

<b>361.25</b>		96	128	160		21	24	25
		131	165	205			20	25



<b>362.21</b>			16
			30
			21
			30



<b>462.25</b>		96	128	160		21	24	25
		130	165	205			20	25



<b>362.21A</b>			16
			30
			21
			30



<b>396.25</b>		96	128	160		21	24	25
		130	165	205			20	25



<b>362.21D</b>			16
			30
			21
			30



<b>498.16</b>		128	192		26
		144	208		16



<b>536.16</b>		128	192		26
		144	208		16



<b>569.28</b>		160	224		28
		167	231		19



<b>832.28</b>		28
		19

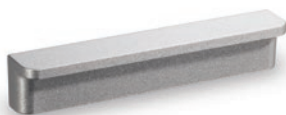

<b>527.13</b>		64	128		15
		80	176		13



<b>527.13B</b>		64	128		15
		80	176		13





a

**370.30**

160



240



25



30

**387.20**

160



275



26



20

**386.20**

160



180



25



20

**311.20**

25



45



20





20



**219.08**



	96		24
	113		8



**219.10**



	128	192		30	31
	150	229		10	10



**304.16**







	96	128		26	30
	113	148		17	22



**583.19**



	96+(128)	128+(160)		22	25
	136	168		19	19



**590.01**

	1
	29
	23
	28

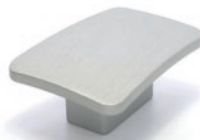
**590.02**

	16
	49
	23
	40

**590.03**

	32
	122
	23
	37

**501.10**

	32
	80
	80
	10

**500.10**

	96
	175
	50
	10

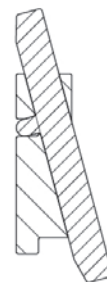
**502.10**

	16
	50
	50
	10

**528.03**

	224	320		28
	233	329		40



**557.02**



32



50



50



20



**557.04**



128



50



175



20



**557.01**



16



80



30



24



**557.03**



64



80



80



24



**437.20**



160

224



19



200

250



20





**667.20**

Σ		29
		28



**199.15D**

Σ		15
		25



**199.15**

Σ		15
		23



**823.18**

⊕		18
		26



**805.13**

⊕		13
		30







**836.26**

Σ		14
		26







**454.20**

Σ		64
		74
		20
		10







**584.19**

Σ		96
		120
		19
		23



**510.34**

Σ		64
		75
		34
		19



**807.24**

Σ		24
		21



**160.12**

⊕		12
		21





834.11



	11
	11
	26



832.28



	19
	19
	28



803.25



	25
	25
	20



825.32



	16
	47
	18



652.20



	16
	20
	55



653.15



	16
	15
	25



833.20



$\phi$	20
	28



850.40



$\phi$	40
	30



613.27B



	16
	30
	27
	7



567.19



	23
	19



328.20B



	22
	20

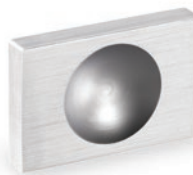

564.27



	32
	40
	27
	8





NOVO  
NEW

**851.40**



Φ 40

26



**851.30**



Φ 30

26



**163.26**



Φ 26

28



**809.24**



Φ 24

28

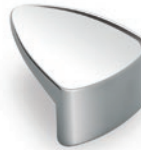

**367.20**



16

30

21

27



**311.20**



25

45

20

20



**819.32**



32

17

27



**804.15**



24

12

19



**362.21C**



16

30

21

30



**362.21B**



16

30

21

30



**826.30D**



30

24

30



**826.30B**



30

25

30



**170.18**  
Σ | φ 26  
| 13



**161.19**  
Σ | φ 19  
| 15



**162.24**  
Σ | φ 24  
| 20



**MS 7.25**  
Σ | φ 25  
| 20



**MS 5.20**  
Σ | φ 20  
| 23



**MS 5.25**  
Σ | φ 25  
| 29



**MS 6.38**  
a | φ 38  
| 32



**MS 6.32**  
a | φ 32  
| 27



**MS 6.25**  
a | φ 25  
| 24



**MS 3.28**  
Σ | φ 28  
| 21



**MS 4.28**  
Σ | φ 28  
| 21







**630.15**



	160	320	512		38
	175	335	527		15



**636.15**



	160		22
	182		15



**667.20**



	1	128		29
	28	198		28(20)





## 2.2 vintage

a

**650.12**

	1	160		33
	35	210		12

**657.16**

	1	160		39
	35	210		16

**347.20**

	160	224		30
	170	234		20



<b>354.25</b>		96	128	192		28	24	28
		115	156	226		25	20	25



<b>516.30C</b>		128		24
		170		30



<b>826.30C</b>		1
		30
		24
		30

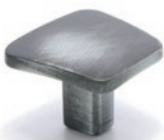

<b>590.01</b>		1
		29
		23
		28

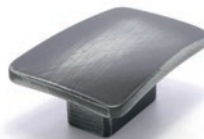

<b>590.02</b>		16
		49
		23
		40



<b>590.03</b>		32
		122
		22
		37





a

**651.24**

	32	96	160		20
	110	180	250		24

**668.15**

	160	224		29
	218	282		15

**619.10**

	160	270	370		36
	197	307	407		10





**387.20**



160



26



275



20



**386.20**



160



25



180



20



**583.19**



96(128)

128(160)



22

25



136

168



19

19



**561.20**

	1	64	110	160	210	260	360	560	660	760	960		29
	100	164	210	260	310	360	460	660	760	860	1060		20

**415.26R**

	96	128	192		27
	102	134	198		12

**529.27**

	96	128	160	192	256		27
	113	150	190	222	286		9



613.27B



	16	128	160	224	320		27
	32	160	224	320	416		7



NOVO  
NEW

700.14



	160	224	320		18
	200	264	360		14

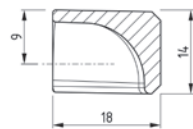

U9.41/41



	28		41
	fi35		13,5
	41		2

U9.175/55



	160		55
	46x168		13,5
	175		2





## 2.2 vintage

**454.20**

	96
	74
	20
	10

**199.15D**

	1
	15
	25
	15

**851.30 / 40**

	1	1
	26	26
	30	40

**589.01**

	1		23
	43		26

**589.02**

	128		25
	140		30

**448.51R**

	76		51
	95		17

**449.95**

	56		95
	95		15



**2202C**



	140
	39
	41



**2187C**



	100
	39
	33



**2202A**



	140
	39
	41



**2187A**



	100
	30
	33



**2084**

103



7



58

**2130**

100



50



50

NOVO  
NEW**40.010**

94



31



39

**2116.2**

715



80x80

LX

**2203.2**

715



60x60

LX



more information in the chapter "furniture legs"  
več informacij v poglavju "pohištvene noge"

**2116.1**

10



80x80

LX

**2203.1**

10



60x60

LX









<b>631.22B</b>		192	288	416		29
®		215	340	465		22



<b>667.20</b>		1	128		29
⌘		28	198		28(20)



<b>650.12</b>		1	160		33
⌘		35	210		12





<b>589.02</b>		128		25
		140		



<b>589.01</b>		1
		43
		23
		26



<b>516.30C</b>		128		24
		170		

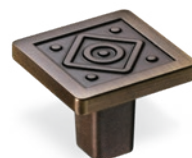

<b>826.30C</b>		1
		30
		24
		30



<b>516.30B</b>		128	192		25
		170			



<b>826.30B</b>		1
		30
		25
		30



**236.16**



128



26



160



16

**128.18**



28



18



**681.15**



128



26



144



15



**386.20**



160



25



180



20

**311.20**



25



45



20



20



**416.14**

64



95



48



14

**815.14**

1



32



50



14

**298.12**

96



120



65



14

**220.10+P4**

64



105



25



15

**851.30**
 $\phi$  30

26

**MS 3.28**
 $\phi$  28

22

**MS 7.25**
 $\phi$  25

20



**162.24**  
Σ |  $\phi$  24  
Σ | 20



**199.15D**  
Σ | 15  
Σ | 25



**170.18**  
Σ |  $\phi$  26  
Σ | 13



**114.30**  
Σ Σ |  $\phi$  30  
Σ Σ | 26



**114.30+P3**  
Σ Σ | 70  
Σ Σ | 30



**118.30**  
Σ Σ |  $\phi$  30  
Σ Σ | 28



**171.32**  
Σ Σ |  $\phi$  32  
Σ Σ | 26



**259.18**  
Σ Σ | 128  
Σ Σ | 148  
Σ | 34  
Σ | 20



**285.13**  
Σ Σ | 128  
Σ Σ | 135  
Σ | 31  
Σ | 17





**636.15**



	160		22
	182		15



**269.22**



	128		30
	162		23



# BAKERI / COPPER

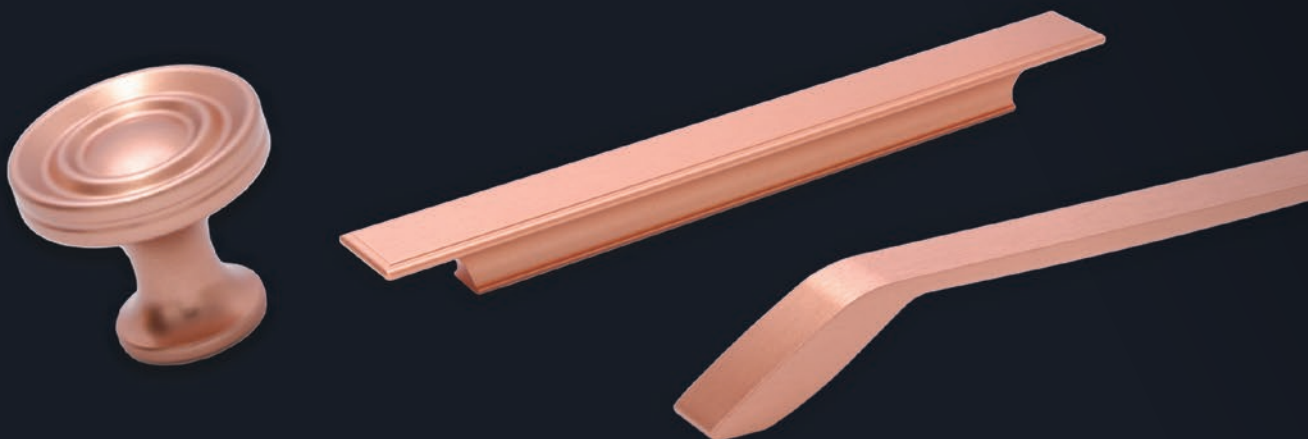



a



# ZLATA / GOLD





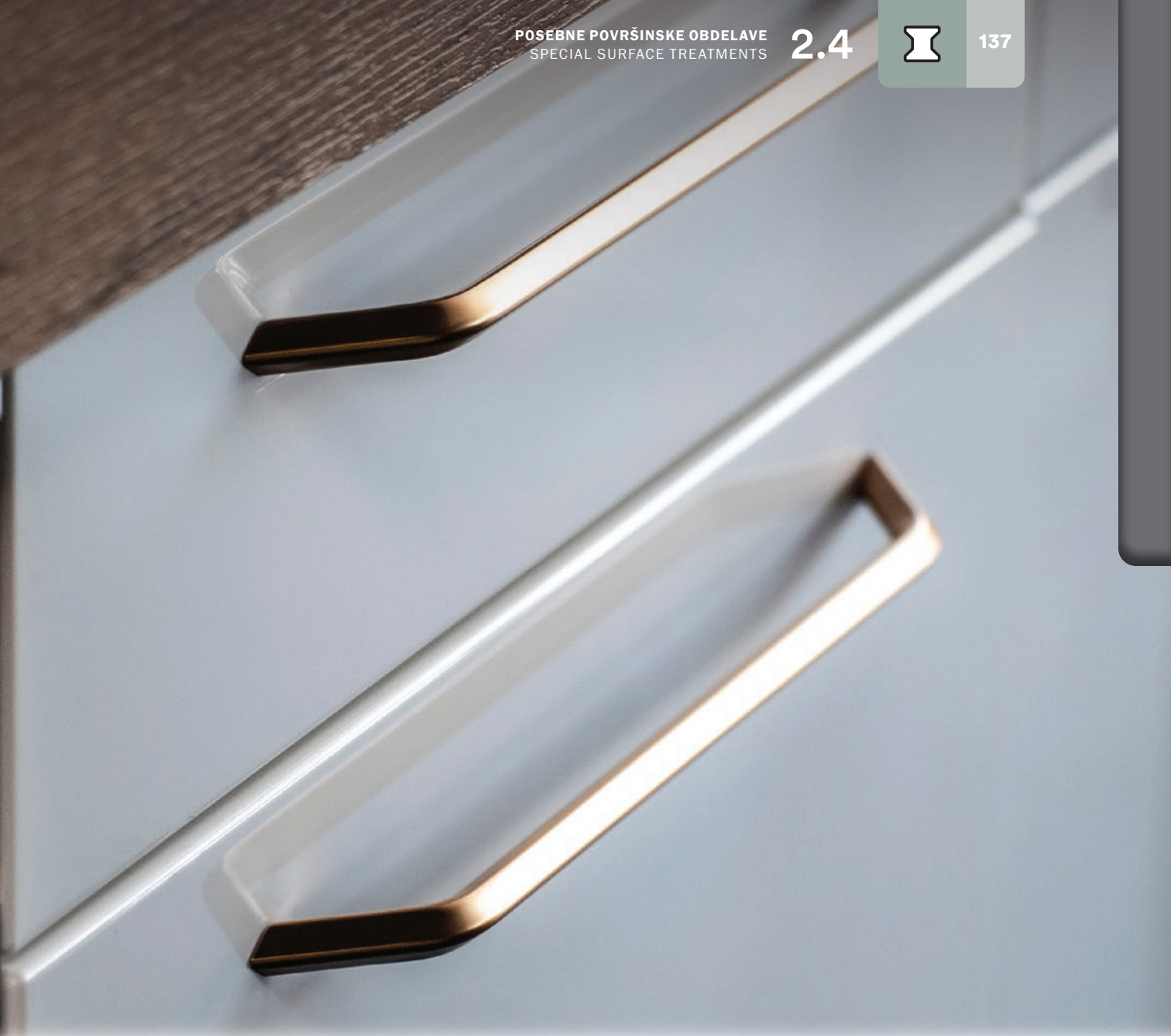

# BRON / BRONZE



# wooden handles and knobs

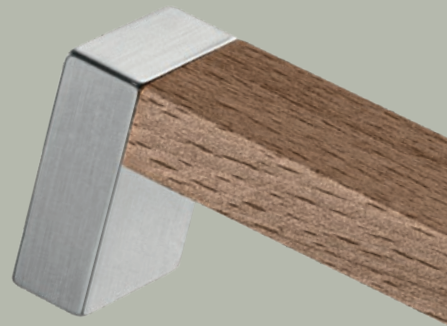

# leseni ročaji in gumbi





**414.14**



96



34



350



14



**613.27B**



16

128

160

224

320



27



32

160

224

320

416



8



**347.20**



160

224



30



170

237



20



**289.26**

		160	224	320	30
		170	234	330	

**166.10**

		26
		30
		10



**556.10**

		128	160	224	320	416	32
		166	198	262	358	454	

**830.10**

		30
		32
		10



**539.01A**

		16
		40
		24
		40

**539.02A**

		96
		162
		24
		40

**539.03A**

		96
		216
		24
		40





**493.35**

	96	128	288	320		35
	115	147	307	339		15



**350.43**

	160	224	288		31
	168	232	296		43



**476.15**

	170	270	320	370		38
	182	282	332	382		15



541.15



160 224



30



170 243



15



237.13



160 192



210 242



30



13

285.13



96 128 192



103 135 199



31



17

259.18



128 160



148 180



34



20



204.16



96



31



112



16

213.14



96



23



126



14

221.10



96



24



133



10

**U1.150**

	50		11
	55		6

**U3.150**

	50		11
	68		5

**U2.150**

	50		11
	55		5

**U2.140**

	40		11
	45		5

**U2.135**

	35		11
	40		5

**114.30**

	30		26

**114.30+P3**

	70		28
			30

**118.30**

	30		26





**810.18**  
♻️ ∑

∅	18
⊞	27



**132.25D**  
♻️ ∑

∅	25
⊞	31



**149.35**  
♻️ ∑

∅	35
⊞	27



**144.32**  
♻️ ∑

∅	32
⊞	30



**171.32**  
♻️ ∑

∅	32
⊞	26



**L1.05.36**  
♻️

∅	35
⊞	34



**L1.03.32**  
♻️

∅	32
⊞	28



**L1.04.35**  
♻️

∅	35
⊞	37





# plastic and leather handles

# plastični in usnjeni ročaji





<b>154.40</b>	$\phi$ 40
	25



<b>816.70</b>	$\phi$ 68
	27



<b>842.30</b>	$\phi$ 48
	30



<b>847.24</b>	$\phi$ 55
	24



<b>155.40</b>	$\phi$ 40
	28



<b>277.32</b>	32	15
	50	27



<b>472.52</b>	32	23
	55	50



<b>469.50</b>	32	23
	60	49



<b>470.50</b>	32	23
	55	49



<b>471.55</b>	32	23
	41	55





<b>506.32</b>	32	30
	$\phi$ 62	26





<b>601.26</b>	32	26
	97	85





843.22 ☘		45
		22
		41





844.24 ☘		70
		24
		52



845.27 ☘		1
		27
		52



846.25 ☘		53
		25
		56



169.30 ☘ Σ		30
		32



117.30 ☘		28
		30



106.14 ☘		15
		25



132.25D ☘ Σ		25
		31



109.20 ☘		20
		24





118.30 ☘ Σ		30
		28



114.30 ☘ Σ		30
		26



171.32 ☘ Σ		32
		25





<b>600.01</b>		64		87
		50		23



<b>600.02</b>		64		87
		50		23



<b>600.03</b>		64		87
		50		23



<b>600.04</b>		64		87
		50		23



<b>600.05</b>		64		87
		50		23



<b>600.06</b>		87		87
		23		23



<b>600.07</b>		64		87
		50		23



<b>600.08</b>		64		87
		50		23



<b>600.09</b>		64		87
		50		23



<b>600.00</b>		64		87
		50		23



828.40		40
		30
		40

829.100		24		36
		100		100

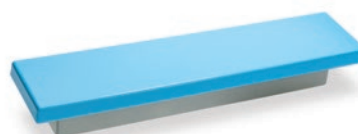

596.22		64		22
		110		110

597.22		64		22
		130		34



598.32		128		32
		144		20

599.30		160		30
		205		60



530.24		160		26
		171		12

302.20		96	128	160	224
		108	140	175	238
		27	27	30	34
		17	20	20	20





222.13		128	160	288
		188	220	348
		32		
		12		



104.14		15
		18



285.13		128		31
		135		17



U2.150		50		12
		55		5



331.16		160		33
		198		16



801.16		35
		24
		16





241.08		64		28
		96		

299.08		96		25
		116		



2153		73
		70
		3

2154		70
		70
		4

2155		64
		69
		3



2156		73
		50
		4

2157		137
		73
		3





591.15		16	160		22
		30	200		32



592.15		160		25
		169		30



516.30F		128	192		29
		185	249		45



826.30F		47
		27



322.16



160 320



36



230 390



16



577.19



160 544



40



215 630



19



855.25



25



69



157.16



Φ 20

42





# hooks



# obešalniki





<b>40.004</b>			
Σ	100	61	47



NOVO  
NEW

<b>40.005</b>			
Σ	117	50	40



NOVO  
NEW

<b>40.010</b>			
Σ	94	31	39



NOVO  
NEW

<b>40.008</b>			
Σ	40	40	45



NOVO  
NEW

<b>40.009</b>			
Σ	30	30	34





<b>2123</b>			
Σ	119	75	47



<b>2124</b>			
Σ	115	70	47



<b>2130</b>			
Σ	100	50	50



<b>2131</b>			
Σ	11	11	26

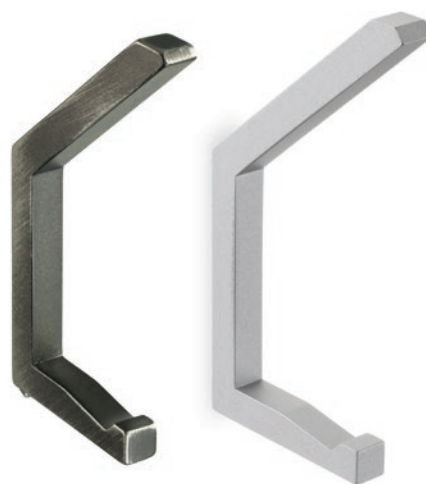

<b>2084</b>			
Σ	103	7	58





<b>40.003</b>			
	76	80	46



NOVO  
NEW

<b>40.003B</b>			
	28	73	32



<b>2046</b>			
	47	163	41



<b>2045</b>			
	39	89	32





**2202A**

	140	39	41



**2187A**

	100	30	33



**2187C**

	100	39	33



**2202C**

	140	39	41



**2018**  

186	45	60



**2053**  

55	64	31



**2037**  

29	13	26



**2100**  

16	47	32	18

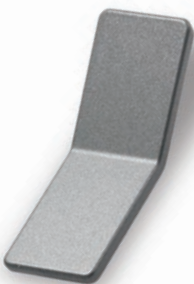

**652.20**  

16	55	20	17



**2127**  

20	20	28





**2088**

130	49	35



**2121**

130	30	35



**2014**

123	60	40



**2028**

116	87	51



<b>2013</b>			
	100	67	51

<b>2030</b>			
	147	25	60

<b>2015</b>				
	128	46	172	40



<b>2001</b>			
	150	55	53



<b>2004</b>			
	215	107	66





<b>2043</b>			
	55	318	43



<b>2033</b>			
	80	80	33



<b>2120</b>			
	60	41	43

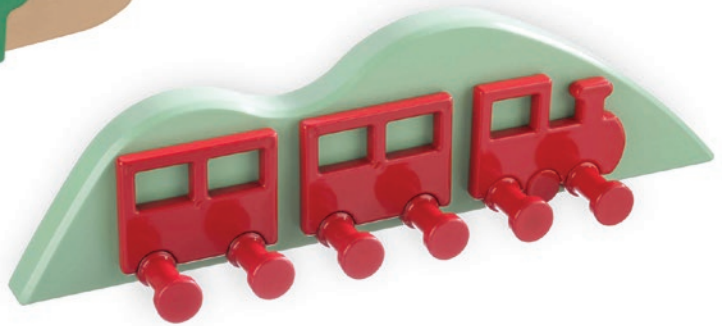
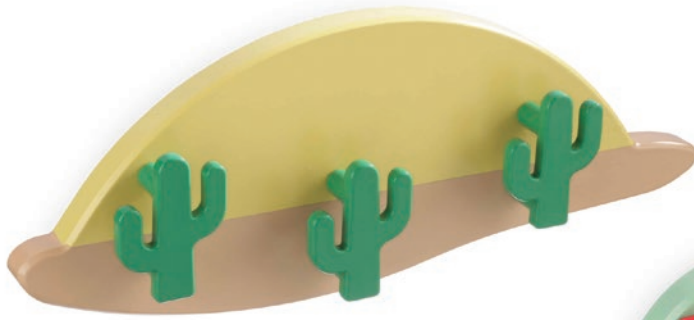

<b>2081</b>			
	110	294	38

<b>2082</b>			
	86	280	38



<b>2010</b>			
	300	300	44

<b>169.30</b>			
	32	30	30

<b>2087</b>				
	45	90	90	18





**TA 2090-92 SET**

**2x TA 2090-92 + 2x 2090-92**



250x1500x50



**2090**



100	100	36



**2092**



40	40	30



**2090 1x / 2092 2x**



227x160x40





# cubus profiles system

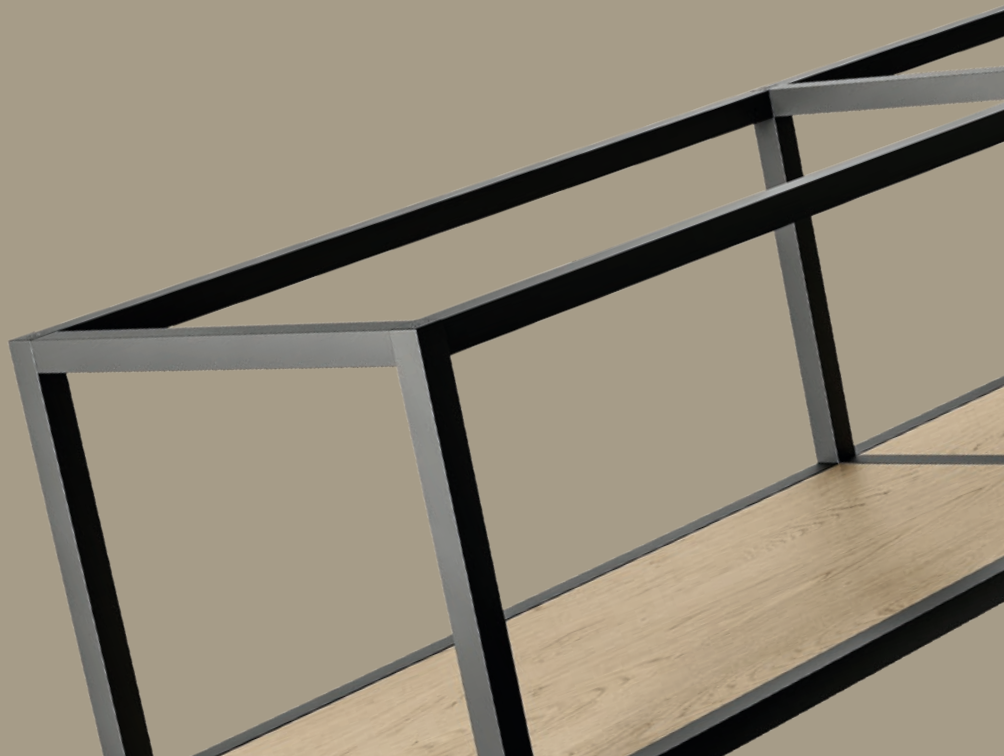

# cubus profilni sistem

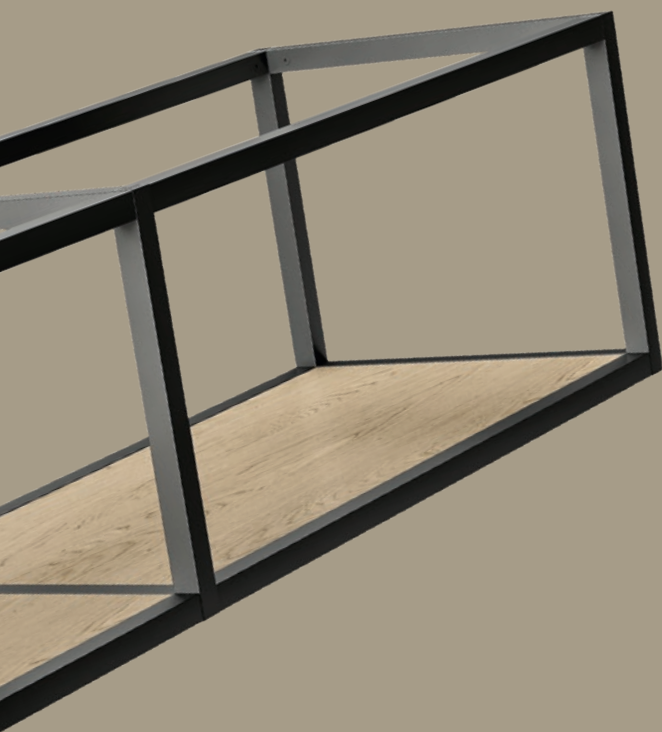



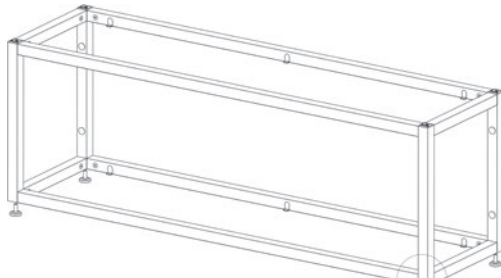
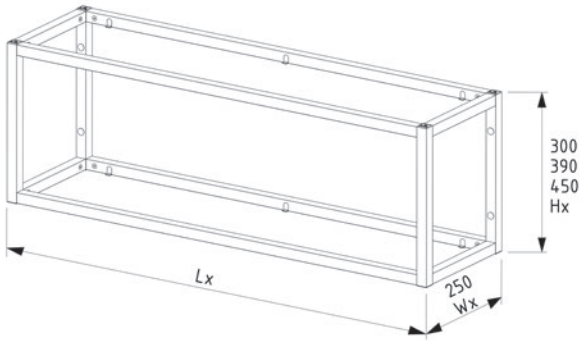

**61.001/1x1**  
CUBUS 1/1



**61.001/2x1**  
CUBUS 2/1



**61.001/1x2**  
CUBUS 1/2



**61.001/1x2**  
CUBUS 2/2

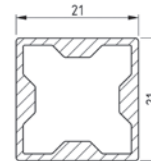
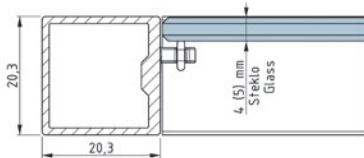

**VERTIKALNI PROFIL**  
VERTICAL PROFILE

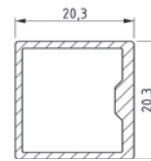
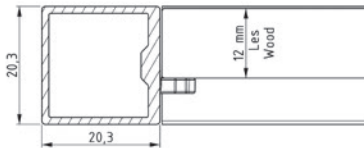

**HORIZONTALNI PROFIL**  
HORIZONTAL PROFILE

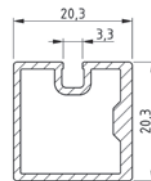
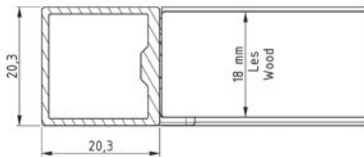

**PROFIL ZA DRSNA VRATA**  
SLIDING DOOR PROFILE

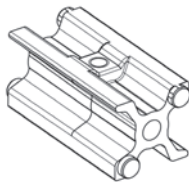

**VEZNI ELEMENTI**  
CONNECTING PLACE

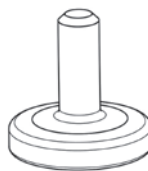

**NIVELATOR**  
LEVELER



**PLASTIČNI POKROV**  
PLASTIC COVER



**NOSILEC LESENE POLICE 18 (19) MM**  
HOLDER FOR WOODEN SHELF 18 (19) MM



**NOSILEC STEKLENE POLICE 4 (5) MM**  
HOLDER FOR GLASS SHELF 4 (5) MM



**NOSILEC LESENE POLICE 12 MM**  
HOLDER FOR WOODEN SHELF 12 MM



**OSNOVNI CUBUS / BASIC CUBUS 1X1**

BC61.02/1X1/WW

**OSNOVNI CUBUS / BASIC CUBUS 1X1**

CB61.01/1X1/GW

**POLIČNIK CUBUS / TOWER CUBUS 1x5**

CB61.03/1X5/5W

**SESTAVLJEN MULTI CUBUS / COMPOUND MULTI CUBUS 2x4**

CB61.08/2X4/4W





# legs & leg frame system





# noge & podnožni sistem





<b>2178R</b>		100	150	200
		+10		
		50x6		



<b>2184B</b>		100	150	200
		+10		
		20x20		



<b>2150</b>		100	150	180
		+5		
		37x37		



<b>2158</b>		50	75	100
		+10/-5		
		40x40		



<b>2064</b>		65	75	125
		+10		
		33x33		



<b>2067</b>		105		
		+10		
		25x25		



<b>2073</b>		110		
		0		
		70x70		



<b>2066</b>		110		
		+10		
		Φ 35		



<b>2070</b>		100		
		0		
		Φ 40		



2072		230
		0
		100



2151		180
		0
		70



2062		70	130
		+10	+10
		50	50



2059		20	40	60
		0		
		75x75		



2057		30	40
		+15	
		100x100	

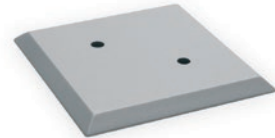

2017		30	40
		+15	
		100x100	



2152		110
		60x60



3002		22
		0
		52x52



# SPOJ

## DESK TOP+DESK LEG



PS 2116.5/80  
PS 2116.5/100  
PS 2203.5/60  
PS 2203.5/80

MS 2116.1  
MS 2203.1



alu okrasni element decorative plate	<b>PS 2116.5/80</b>		86x86	10
alu okrasni element decorative plate	<b>PS 2116.5/100</b>		100x100	10
spojni mehanizem joint	<b>MS 2116.1</b>		80x80	10
alu noga alu leg	<b>NG 2116.2A</b>		80x80	715,
drsni slider	<b>DR 2116.3</b>		80x80	5
regulator leveler	<b>RE 2116.4</b>		fi 40	+5

**60 x 60 / MS 2203.1**

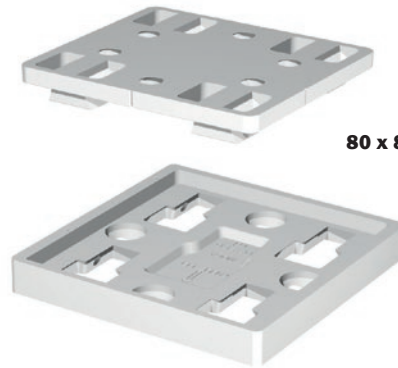
**80 x 80 / MS 2116.1**

**rd PATENTIRAN MEHANIZEM**  
**PATENTED MECHANISM**

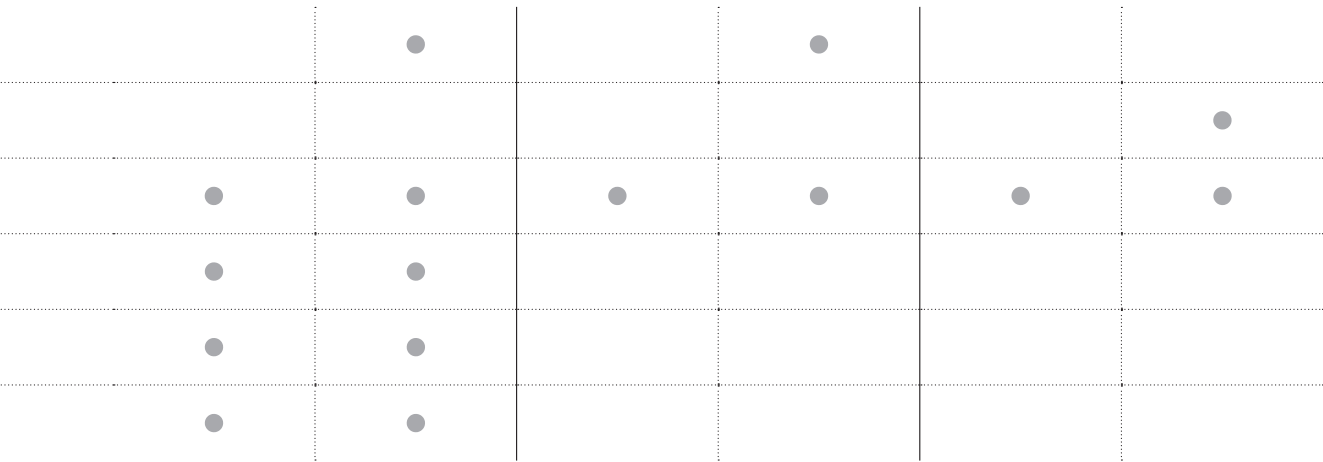
alu okrasni element decorative plate	<b>PS 2203.5/60</b>		65x65	10
alu okrasni element decorative plate	<b>PS 2203.5/80</b>		80x80	10
spojni mehanizem joint	<b>MS 2203.1</b>		60x60	8
alu noga alu leg	<b>NG 2203.2A</b>		60x60	715,
drsni slider	<b>DR 2203.3</b>		60x60	3
regulator leveler	<b>RE 2203.4</b>		fi 28	+5

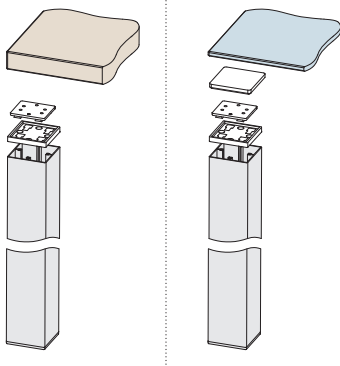

**80x80**  
alu noge / alu legs



**60x60**  
alu noge / alu legs

**80x80**  
lesene noge / wooden legs

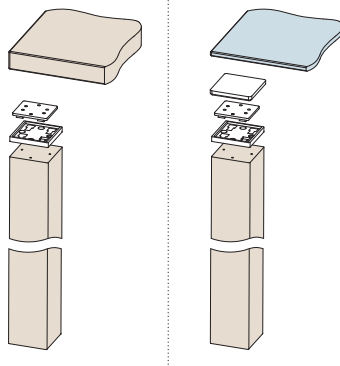

**60x60**  
lesene noge / wooden legs

**100x100**  
lesene noge / wooden legs

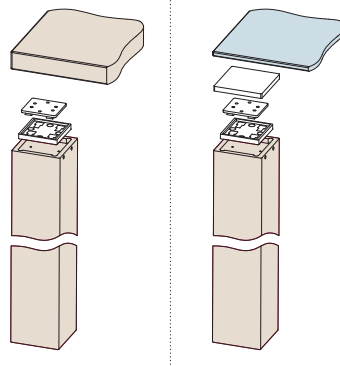

**60x60**  
lesene noge / wooden legs

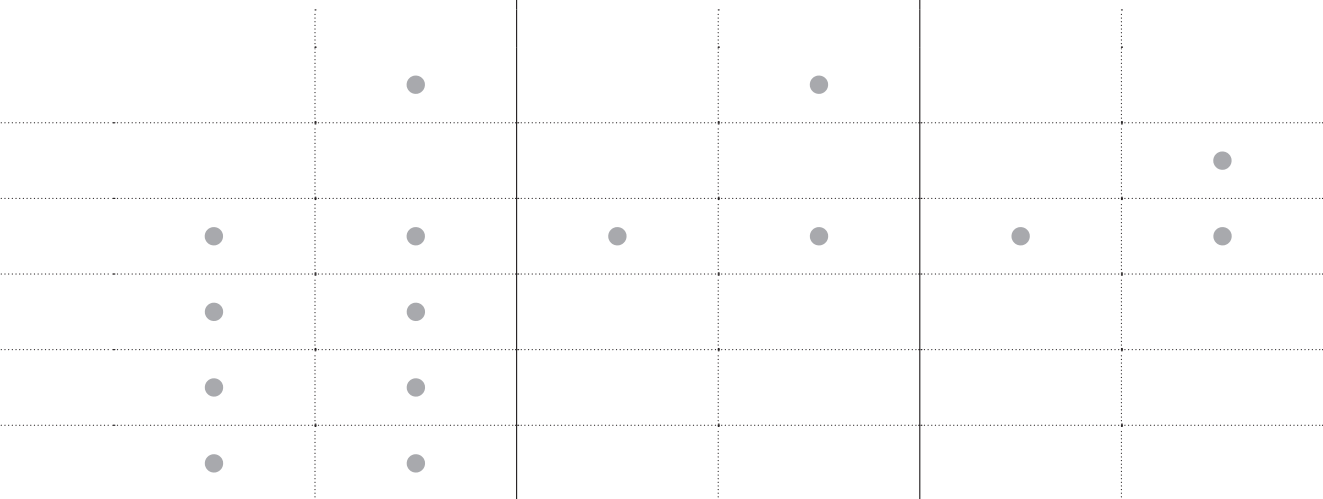





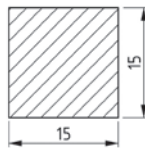

30.001

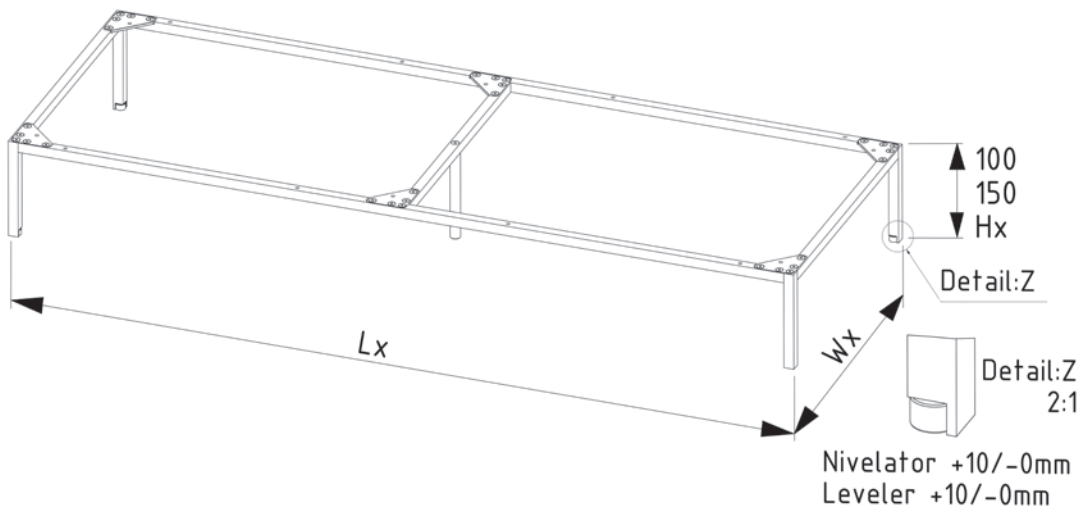



# galvanization and custom products

# galvanizacija ter posebni izdelki





## RUJZ DESIGN GALVANIZACIJA

Naše podjetje je specializirano za galvanizacijo izdelkov oziroma njihovih sestavnih delov, ki zahtevajo veliko pozornosti in natančnosti. Kromirana površinska obdelava je odličen način, kako narediti izdelek vizualno privlačnejši. Svetleča prevleka pa je obenem tudi zaščita pred korozijo in obrabo.

**rd Galvanizacija** vam poleg galvanizacije ponuja tudi lastno storitev robotskega ter ročnega poliranja.

## RUJZ DESIGN GALVANIC COATINGS

The company is specialized in decorative component coatings, visible parts of products requiring high attention to detail throughout the galvanizing process. The galvanic surface treatment is a great way to increase the visual appeal of any part as well as protect it from corrosion, wear and tear.

**rd Galvanic Coatings** offers additionally an in-house robotic polishing service.





Chrome



Nickel



Black Nickel

## DIMENZIJE IN TIPI GALVANSKIH OBDELAV

**Maksimalne dimenzije:**  
1450 x 700 x 400 mm

**Maksimalna površina:**  
180 dm<sup>2</sup>

**Materiali za obdelavo:**  
Aluminij, nerjavna jekla (inox), medenina

**Vrste površinskih obdelav:**  
Krom, nikelj in črni nikelj

\*Vse vrste površinskih obdelav so na voljo na vseh razpoložljivih materialih za obdelavo.

## DIMENSIONS AND FINISHES

**Maximum dimensions:**  
1450 x 700 x 400mm

**The maximum  
surface area of a piece:**  
180dm<sup>2</sup>

**Materials:**  
Aluminium, steel, inox,  
and brass

**Finishes available:**  
Chrome, Nickel, Black Nickel

\*All the finishes are possible in all the materials mentioned.



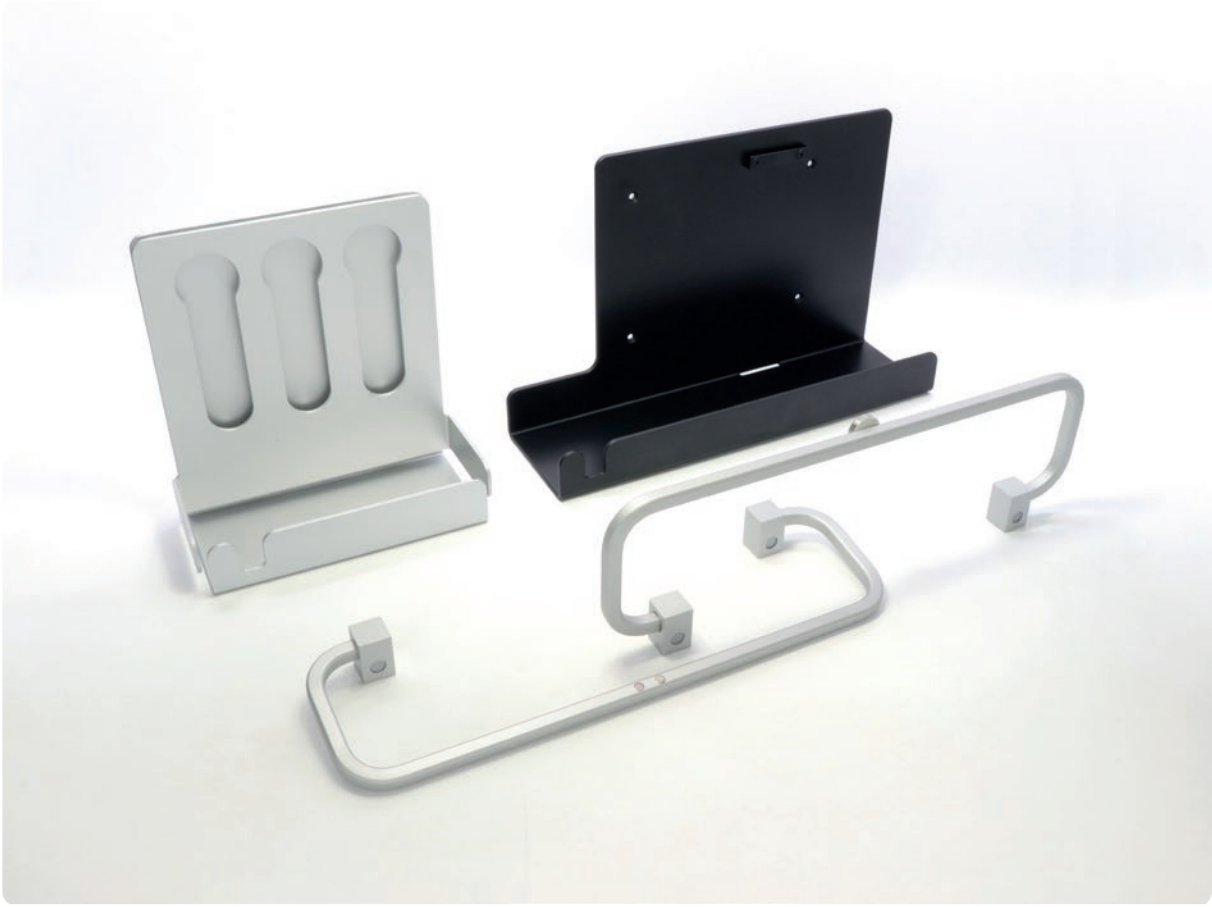

2016



IS

SL

TR

117

50

40

## PREZENTACIJE PRESENTATIONS

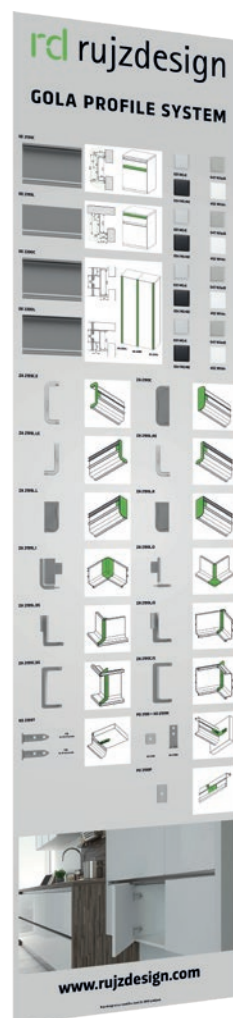

### PRODAJNO RAZSTAVNA PREZENTACIJA

Prezentacijski prodajno-razstavni panel je namenjen prezentaciji programa na fleksibilen način, saj omogoča hitro menjavo vzorcev in nadomeščanje le teh z novimi, aktualnejšimi modeli. Dimenzije panela so 450 x 2200 mm, lahko pa jih razširimo v 2, 3 ali več delne prezentacije, glede na zanimanje in razpoložljivost prostora. Prezentacija je lahko stenska, lahko je prostostoječa na podstavku, enostranska ali dvostranska. Izbor modelov je fleksibilen in prepuščen dogovoru.

### DISPLAY PANEL

The display panel is specifically designed to allow easy and quick changes to your handles presentation. Each one measures 2200 mm in height and 450 mm in width. Multiple panels can be joined together as per your wishes and available space. It can be mounted on a wall or self-standing on a base, which also enables two-sided presentations. The product selection to be presented on these panels is according to an agreement.

### PREZENTACIJA PROGRAMA GOLA

Prezentacijski panel programa Gola je oblikovan tako, da so predstavljeni vsi sestavni deli tega projekta, vse oblike alu profilov v vseh možnih površinskih obdelavah in vse možne kombinacije kotnih spojev in zaključkov.

### GOLA PROGRAM PANEL

This panel displays every component and profile design of the Gola program, as well as possible surface finishes and combinations of corner joints and end caps.





## PREZENTACIJA POVRŠINSKIH OBDELAV

Prezentacija površinskih obdelav je namenjena našim večjim partnerjem, arhitektom in oblikovalcem ter prodajnim zastopnikom. Glede na veliko količino različnih površinskih obdelav lahko iz te prezentacije natančno ocenite ustreznost in lastnosti posameznih površinskih obdelav. Na kratko so predstavljene tehnologije in skupine površinskih obdelav.

## SURFACE FINISH CATALOGUE

Designed for our partners, architects, designers and sales representatives. Accurate presentation on aluminium plates allows for precise evaluation and comparison between a wide variety of surface finishes. Included is a description of every surface finish group.



## PREZENTACIJA Z ALU PROFILI

Prezentacija alu profilov je namenjena našim večjim partnerjem, njihovim tehnologom, arhitektom in oblikovalcem in našim prodajnim zastopnikom. V prezentaciji so zajeti vsi aktualni profili, iz katerih so izdelani posamezni tehnični projekti.

## ALUMINIUM PROFILE DESIGN COLLECTION

A collection of a large variety of recent aluminium profile extrusions. Intended for our major partners and their engineers, architects and designers, as well as our sales representatives.

**rd** rujzdesign

Rujz design d.o.o.  
Letališka cesta 32  
SI-1000 Ljubljana  
Slovenija

T +386 (0)1 542 22 00  
F +386 (0)1 521 12 10

info@rujzdesign.com  
www.rujzdesign.com

izdajatelj/publisher  
**Rujz design**  
zasnova in oblikovanje/concept and design  
**Innovatif**  
fotografa/photographers  
**Aleksander Lilik, Anja Rugelj**  
tisk/printed by  
**Kocman grafika**  
Ljubljana 2022



